



ECONAD



PRODUCT CATALOGUE



CLEANING • RESTORATION • PROTECTION



03	—	“Econadin” oil absorbent
06	—	Oil Containment Booms
25	—	Floating Security Barrier
31	—	Dredging buoys
33	—	Skimmer industrial
38	—	Oil spil skimmers
52	—	Oil spill kits
55	—	Oil Absorbent products
56	—	Chemical Absorbent products
57	—	Water Absorbents
61	—	Air lifting bags & Waterweight for weight testing
64	—	Berms and temporary tanks
72	—	Cleaning agents
73	—	Related products



BIOSORBENT "ECONADIN"

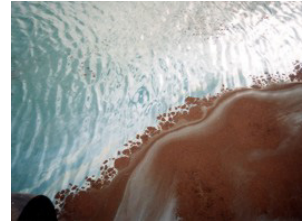

Oil Absorbent ECONADIN ("Ecological hope") – a unique natural oil absorbent.

Oil Biosorbent "Econadin" – is a unique natural absorbent of oil with a high absorption capacity. It's a combination of avirulent bacteria-superdestructors of oil hydrocarbons, immobilized by a special technology on a natural organic substrate – high-moor sphagnum peat.

ECONADIN is a modern and environmentally friendly solution for oil and oil product spill response, chemically hazardous substances and organic oils spills.

Does not require disposal!

APPLICATIONS:

- marine industry
- oil and gas industry
- chemical industry
- industrial enterprises and factories
- aviation companies
- railway companies
- transport companies, gas stations, service stations
- other facilities where petroleum products are used

Characteristics of the biological product "Econadin"

Carrier: high sphagnum peat

The base of ECONADIN is avirulent oil-oxidizing bacteria

Absorption capacity: from 1: 4 to 1: 8 (1 kg of "Econadina" sorbs 4-8 kg of oil products)

Desorption: practically absent

Properties: It is hydrophobic and buoyant. Environmentally friendly, non-toxic, odorless, safe for humans, animals and the environment.

Shelf life: 5 years



E-mail: contact@econadin.com
WhatsApp Business: +380667404649
Web: www.econadin.com,
www.econad.co.uk





ECONAD

BIOSORBENT "ECONADIN"

The Oil Biosorbent "ECONADIN" combines the best absorption properties of organic sorbents with the destructive properties of microbial agents. Specially selected bacteria (at a concentration of 10^7 per gram of the product) oxidize petroleum hydrocarbons into water (H_2O) and carbon dioxide (CO_2).

SANITARY AND ENVIRONMENTAL SAFETY:

- Protected by Ukrainian patents.
- Approved by the Ministry of Health of Ukraine (State Sanitary and Hygienic Expertise conclusion for domestic product "Sorbent-Biodestructor Econadin").
- Recommended by the Ministry of Ukraine for Emergency Situations and Protection of the Population from the Consequences of the Chernobyl Disaster.
- Endorsed by the Ministry of Ecology and Natural Resources of Ukraine.
- Supported by the Environmental Protection Inspectorate of the Northwest Black Sea Region.
- ISO 9001:2015

ADVANTAGES OF BIOSORBENT APPLICATION "ECONADIN":

- Elimination of pollution without environmental damage.
- Rapid containment of oil pollution in a minimal time frame.
- Localization of oil spills and prevention of further spread of petroleum products.
- Promotes the restoration of natural balance and stimulates natural self-cleaning processes.

BIOPREPARATION "ECONADIN" ABSORBS:

- Oil and oil products
- Organic and inorganic oils
- Chemically hazardous substances
- Other aggressive pollutants

The full list of absorbed products can be found at <https://econadin.com/en/production/econadin-oil-absorbent/>



Volume
5 l

Weight
~ 0,7 kg



Volume
20 l

Weight
~ 3 kg



Volume
40 l

Weight
~ 6 kg



Volume
50 l

Weight
~ 7,5 kg



E-mail: contact@econadin.com
 WhatsApp Business: +380667404649
 Web: www.econadin.com,
www.econad.co.uk





OIL ABSORBENT SPRAYER

The self-contained knapsack sprayer is specifically designed for the efficient application of absorbents like “ECONADIN” to areas contaminated by oil and other petroleum products, whether on water or land.



FEATURES:

- + Enhanced Autonomy: The ECONAD sprayer offers increased autonomy, allowing for extended use without the need for frequent refills.
- + High Productivity: Engineered for high efficiency, it ensures rapid application of absorbents to large areas.
- + Operator Convenience: Designed with the operator in mind, the sprayer features easily accessible control knobs and a comfortable harness.
- + Large Capacity: Includes a spacious tank that holds absorbent and fuel separately, reducing downtime.
- + Adjustable Output: Allows for the precise regulation of absorbent discharge to suit various contamination levels and surface types.

This sprayer is ideal for environmental clean-up efforts, providing a practical solution for swiftly managing oil spills with maximum ease and effectiveness.

Basic equipment:

Knapsack sprayer	Pipe nozzle
Capacity 50L / 150L / 250L / 500L / 1000L	Cover
Air suction / blowing device	Sieve mesh
Spray pipe	



E-mail: contact@econadin.com
WhatsApp Business: +380667404649
Web: www.econadin.com,
www.econad.co.uk





OIL CONTAINMENT BOOMS

Oil spill containment booms are an economical and versatile tool for containing oil spills and other pollutants floating on the surface of the water.



ECONAD FLOATING CONTAINMENT BOOMS ARE USED FOR:

- Limiting the spread of pollution on the water surface
- Containment, movement, and recovery of oil in the event of oil spills
- Fencing off oil tankers during cargo operations, providing reliable protection of water areas from pollution
- Containing oil spills
- Protecting coastlines, harbors, rivers, and natural reserves from spilled oil
- Isolating areas contaminated with oil products during cleanup operations

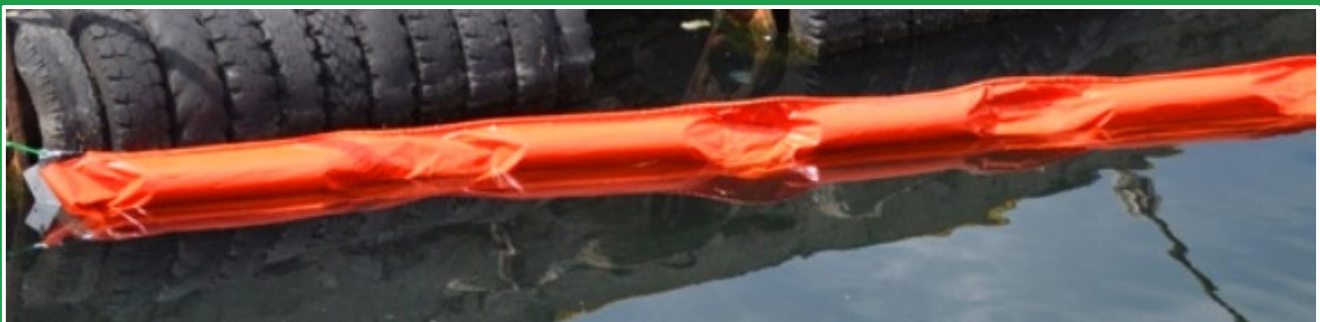

E-mail: contact@econadin.com
WhatsApp Business: +380667404649
Web: www.econadin.com,
www.econad.co.uk





ECONAD

OIL CONTAINMENT BOOMS



Product type	500	750	900	1000	1200
Freeboard (mm)	200	260	320	360	380
Skirt (mm)	300	390	460	560	605
Force tension (mm)	8	15	25	40	50
Application Limits					
Section length (m)	10/15/20	20	20	20	20
Wind speed, (m/s)	8	15	18	20	20
Section weight, (kg)	45	75	130	195	260
Trawling speed, (kt)	1	2	2	2.5	3



E-mail: contact@econadin.com
 WhatsApp Business: +380667404649
 Web: www.econadin.com,
www.econad.co.uk





OIL FLAT CONTAINMENT BOOMS

Boom barriers with a flat float chamber are ideal for rapid containment of oil spills in calm waters such as ports, bays, rivers, and reservoirs. Their compact design ensures quick deployment and easy handling, making them suitable for areas requiring a fast response.

These booms are preferred by port authorities, marinas, oil spill response teams, and industrial facilities near water bodies.



“ECONAD” OIL FLAT BOOMS ARE USED FOR:

- Limiting the spread of pollution on the water surface
- Localizing, moving, and collecting oil in the event of oil spills
- Enclosing oil-carrying vessels during cargo operations, providing reliable protection of water areas from pollution
- Protecting coastlines, harbors, rivers, and nature reserves from spilled oil
- Enclosing areas contaminated with oil products during cleanup operations



E-mail: contact@econadin.com
WhatsApp Business: +380667404649
Web: www.econadin.com,
www.econad.co.uk





OIL FLAT CONTAINMENT BOOMS

Product type	OFB 350	OFB 450	OFB 600	OFB 750
Total height, (mm)	350	450	600	750
Freeboard, (mm)	120	150	200	250
Waterboard/skirt, (mm)	230	300	400	500
Section length, (m)	10, 20			
Power tension, (node)	15	20	25	30
Ballast	ballast chain or block			
Weight, (kg/m)	2.5	3	3.5	4
Package dimensions (60m)	2.8×1.7×0.6	2.8×1.7×0.7	2.8×1.7×0.8	2.8×1.7×0.9
Availability	is	to order	to order	to order



E-mail: contact@econadin.com
 WhatsApp Business: +380667404649
 Web: www.econadin.com,
www.econad.co.uk





ECONAD

BOOMS REELS

An Oil Boom Reel is a crucial device for managing oil spill containment efficiently in marine environments. It is designed to deploy, retrieve, and store oil containment booms, which are essential for controlling oil spills in bodies of water such as oceans, rivers, and harbors.



ADVANTAGES:

- + **Efficient Storage:** Oil boom reels enable tidy and compact storage of lengthy booms, preventing them from tangling and ensuring they are ready for rapid deployment.
- + **Quick Deployment and Retrieval:** These reels facilitate the swift deployment and retrieval of booms, which is vital during emergency responses to oil spills.
- + **Flexible Operation Options:** Available in both motorized and manual versions to suit different operational scales and needs.
- + **Durability and Corrosion Resistance:** Constructed from materials like stainless steel or aluminium, oil boom reels are built to withstand corrosive marine environments, ensuring long-term reliability and performance.

Enhanced Effectiveness: The use of oil boom reels makes the overall process of oil spill containment more manageable and effective, especially in large-scale spills where long stretches of boom are required.

Specifications

Strength, m	200 (booms)
Reason	Electric
Material	Steel, painted with anti-corrosion paint.



E-mail: contact@econadin.com
 WhatsApp Business: +380667404649
 Web: www.econadin.com,
www.econad.co.uk





INFLATABLE OIL HEAVY BOOMS

Special barrier inflatable booms Econad RB5 are designed to contain oily water spills. Manufactured from durable and high-quality materials, the booms perfectly contain oil and other oil products, and are also not exposed to the harmful effects of ultraviolet radiation.



DURING OPERATION,

barrier booms are sufficiently resistant to distortion in the sea and are easy to clean after use, they are quite simple to operate, which will quickly neutralize the consequences of a spill of hazardous substances in the sea in the event of a real threat.



E-mail: contact@econadin.com
WhatsApp Business: +380667404649
Web: www.econadin.com,
www.econad.co.uk





BOOM BARRIERS FOR UNDERWATER CONSTRUCTION WORKS

Silt curtain barriers are vertical, flexible curtains that extend from the water surface down to the bottom, either fully or partially. These curtains are used to reduce water turbidity during construction activities, such as dam injections.

Each curtain consists of the curtain material itself, a heavy chain for stability, and a float that remains on the water surface. Booms are used as floats. The standard length of each curtain is 20 meters, and every 19.5 meters, the curtain is securely anchored to the bottom using anchors and cables.

Curtains are connected to each other with special brackets, ensuring a continuous barrier along the construction area.

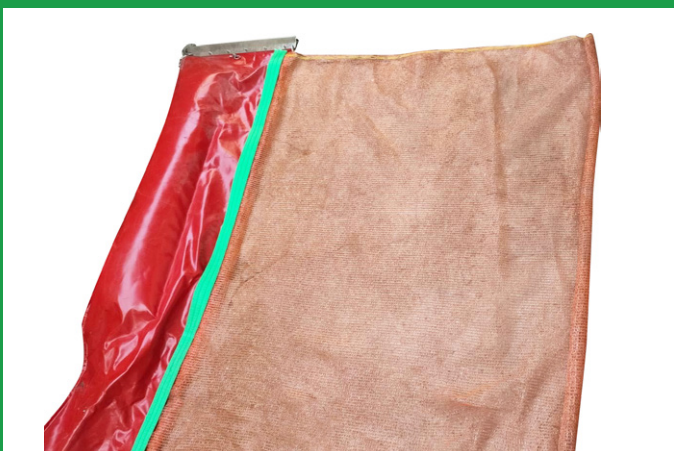

The curtain is made of durable polypropylene fiber. Due to the structure of the material, water easily passes through the fiber, while bottom sediments are retained on the surface.

During operation, the curtains can be repositioned by divers, and the anchors are installed using a floating crane (lifting capacity – 16 tons).



E-mail: contact@econadin.com
WhatsApp Business: +380667404649
Web: www.econadin.com,
www.econad.co.uk





ECONAD ABSORBENT BOOM WITH PVC SKIRT

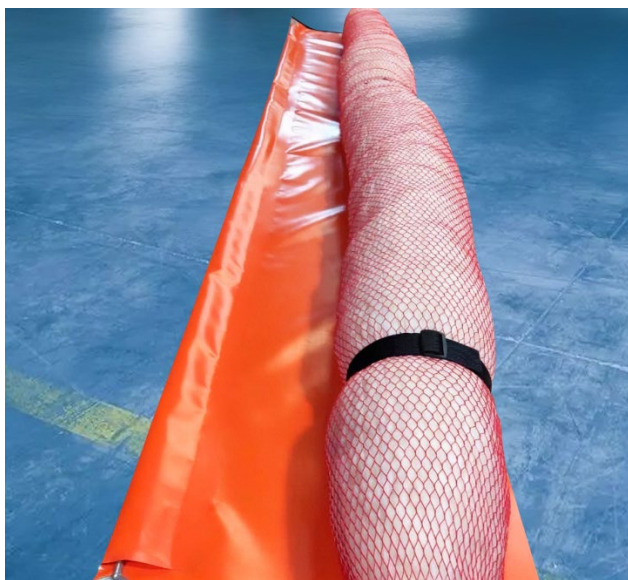

VERSATILE AND EFFICIENT SPILL CONTROL

The ECONAD Absorbent Boom with PVC Skirt offers a flexible solution for spill management. Deploy the boom with the absorbent side facing the spill for effective containment and absorption, or position the skirt side towards the spill to use it as a containment boom, ideal for light debris or mechanical recovery.

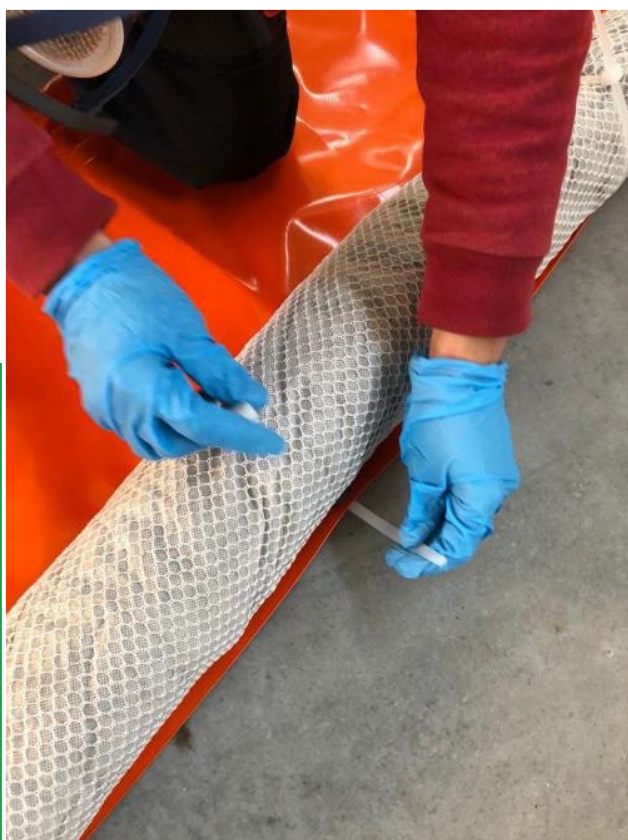

This lightweight, cost-effective boom is supplied in packs of two, providing 10 metres of total coverage when joined.





ECONAD ABSORBENT BOOM WITH PVC SKIRT

Specifications	ECONAD Absorbent Boom 130D with PVC Skirt	ECONAD Absorbent Boom 200D with PVC Skirt
Freeboard	130 mm	200 mm
Draft	320 mm	300 mm
Overall Height	450 mm	500 mm
Section Length	Available in 5-10 m sections	
Buoyancy to Weight Ratio	4:1	
Weight	1.8 kg per meter	2.3 kg per meter
Ballast	5 mm galvanized steel chain	
Material: skirt	600 gsm PVC	
Material: boom	Polypropylene	
Colour: skirt	Orange	
Colour: boom	White	
Diameter of Absorptive Boom	200 mm	
Absorption Capacity	100 liters per boom	131 litres per boom, 262 litres per pack of 2 booms
Connections	<ul style="list-style-type: none"> • Fitted with eye rings • PVC skirt attached to boom with Velcro straps • Velcro connections for joining sections together • Ballast chain connected with small carabiners 	
Note	<p>Freeboard refers to the vertical height of the product above the water.</p> <p>Draft refers to the depth of the product below the water.</p>	





ECONAD Debris Collection Barrier

OVERVIEW:

The ECONAD Debris Collection Barrier is designed to prevent water pollution by effectively containing and collecting floating debris and waste. This barrier is ideal for permanent installations at hydroelectric power stations, tidal intake structures, rivers, seas, harbours, and dams.

FEATURES:

- All components of the ECONAD Debris Collection Barrier and boom barriers comply with international standards.
- High resistance to water and UV radiation.
- Lead weights are placed under the barrier to increase stability.
- The barrier is adapted to water movement, particularly during tidal changes.
- Constructed from rubber material for enhanced durability.
- The barrier has a tensile strength of 400 kg/cm, ensuring reliability in challenging conditions.
- A special high-strength steel wire is available for extreme debris situations.

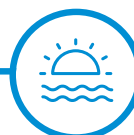
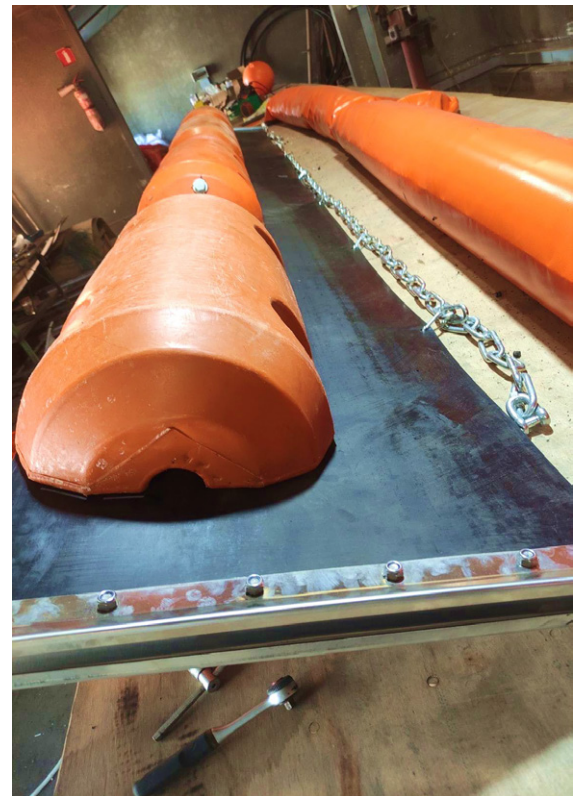
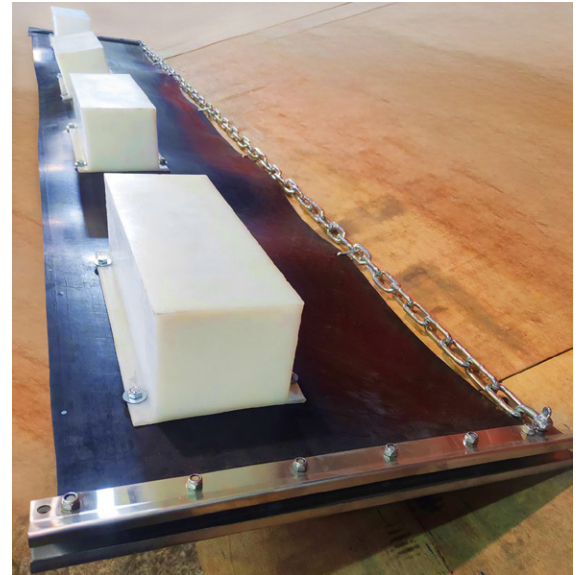



ECONAD

ECONAD Debris Collection Barrier



TECHNICAL SPECIFICATIONS:

The ECONAD Debris Collection Barrier stands out for its high durability and low operational costs. It is made from robust materials resistant to harsh conditions such as abrasion, UV radiation, oil, and marine degradation.

Additional heavy-duty high-density polyethylene (HDPE) nets can be added to the lower part of the barrier to maximise debris capture and increase overall depth below the waterline. Lead weights, ballast, or galvanised chains can be placed under each pair of floats to enhance stability. Standard quick-connect fittings are supplied with each section.

The barrier is constructed with high-quality polyethylene floats attached to a rubber base using corrosion-resistant fittings. Additionally, the floats can be foam-filled to ensure maximum reliability and increased buoyancy.

The floats are easily detachable from the main fabric for cleaning, and if necessary, they can be replaced in case of damage. Anchor attachments can be provided at regular intervals near the floats or end connectors.



E-mail: contact@econadin.com
WhatsApp Business: +380667404649
Web: www.econadin.com,
www.econad.co.uk





ECONAD Debris Booms™

OVERVIEW:

Our ECONAD Debris Booms are advanced floating barriers designed to contain debris, available in various configurations to address a wide range of environmental challenges. The ECONAD series is specifically developed to intercept and retain large volumes of floating debris, including river trash, water hyacinth, and, in certain cases, petroleum products. In colder climates, the ECONAD series also functions effectively as ice barriers, aiding in the formation of upstream ice sheets, which helps prevent frazil ice formation and halts the movement of large ice masses.

KEY APPLICATIONS:

- **Floating Debris Control:** Effectively captures and contains large amounts of floating debris and river trash, preventing their spread.
- **Fish Guidance Systems:** Directs and controls the movement of fish and other aquatic species.
- **Ice Barriers:** Serves as a powerful barrier for managing ice flow in cold conditions.
- **Deflector Barriers:** Protects critical infrastructure from debris by diverting it away from dangerous zones.
- **Oil Spill Management:** Contains bitumen globs and other pollutants in water.
- **River Flow Management:** Controls and directs water flow to prevent erosion and protect infrastructure.

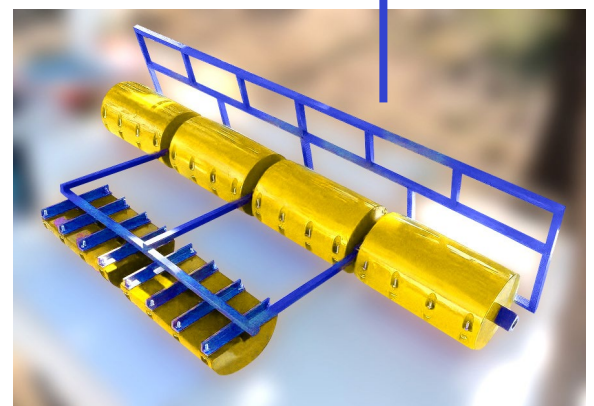
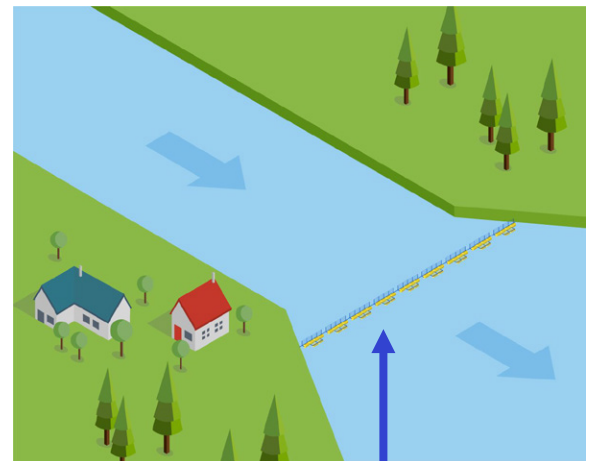

E-mail: contact@econadin.com
WhatsApp Business: +380667404649
Web: www.econadin.com,
www.econad.co.uk





ECONAD

ECONAD Debris Booms™

TECHNICAL FEATURES:

- We offer a variety of design configurations, including different depths and heights of barriers, float materials, to meet specific conditions and requirements.
- Specialised designs for ice flow control.
- Options for directing the movement of different fish species.
- Options for pedestrian walkways and boat access for personnel and equipment.
- Durable materials made of high-density polyethylene (HDPE) and rotomolded floats.
- Designed to handle large debris loads, available in both standard and custom solutions.

SIZES AND SPECIFICATIONS:

ECONAD barriers are typically manufactured in 3- and 6-metre segments for easy transportation, assembly, and installation.

Screen depths can reach up to 3 metres for rigid panels, with hybrid options that allow for extended coverage using flexible nets or screens that reach the river or lake bed. The design also takes into account width restrictions for sea or land transport.

COMMITMENT TO ENVIRONMENTAL PROTECTION:

Floating debris mats, large accumulations of trash, water hyacinth, and logs can clog waterways, hinder power generation, and significantly contribute to ocean plastic pollution. Rivers act as channels that feed man-made waste into the oceans. ECONAD Debris Booms intercept and contain this waste at its source, allowing for easy removal and preventing further environmental contamination.



E-mail: contact@econadin.com
WhatsApp Business: +380667404649
Web: www.econadin.com,
www.econad.co.uk





INFLATABLE OIL CONTAINMENT BOOMS

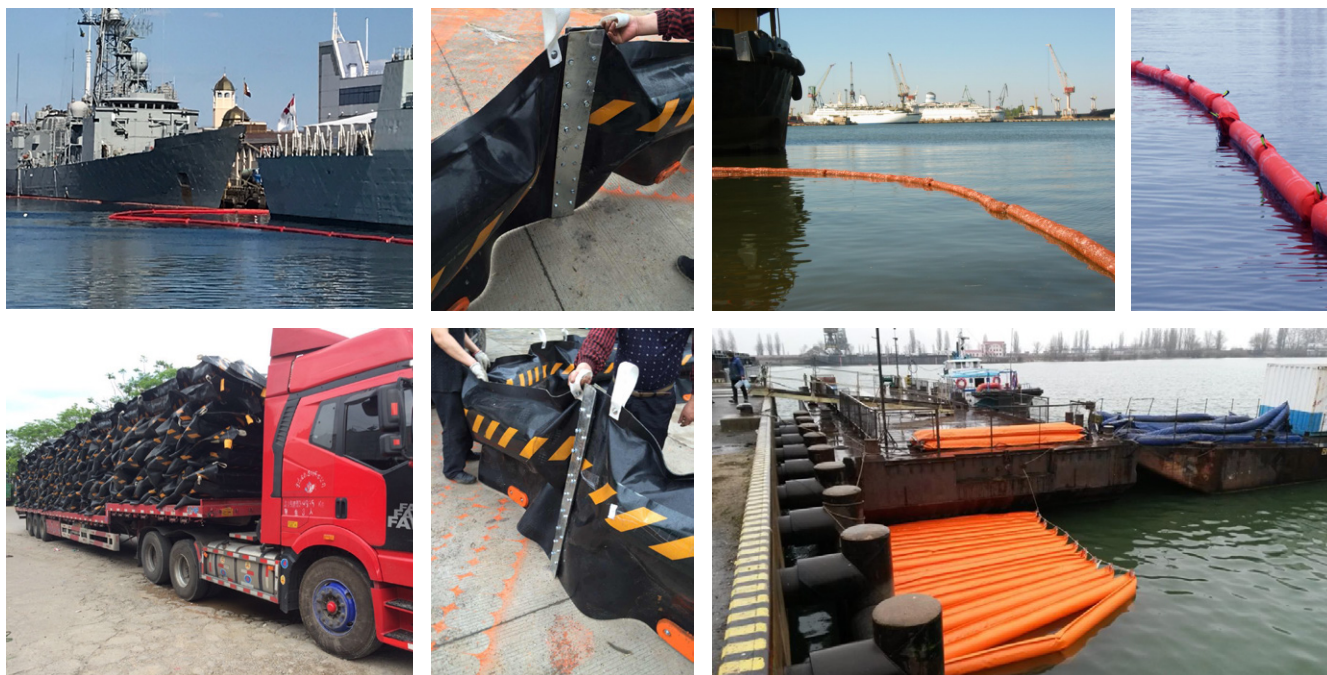

Boom barriers are equipment used for the localization, movement, and collection of oil products during emergency oil spills.

INFLATION BOOMS BARRIERS

Inflatable booms are designed for rapid deployment and localization of emergency oil spills.



Product type	Total height (mm)	Freeboard (mm)	Submarine (mm)	Section Length (m)	Force tension (knots)
HBZ 900	900	320	460		50
HBZ 1100	1100	360	520	50	80
HBZ 1200	1200	400	590		100

Product type	Pressure, (Pa)	Wave height (m)	Sweeping speed, (knots)	Wind speed, (m / s)	Section weight (kg)
HBZ 900		1	2	15	3,6
HBZ 1100	4000-6500	1,5	3	15	5
HBZ 1200		2	3	20	7,8



E-mail: contact@econadin.com
 WhatsApp Business: +380667404649
 Web: www.econadin.com,
www.econad.co.uk

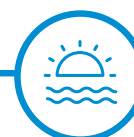



INFLATABLE FLOOD PROTECTION BARRIERS

DESCRIPTION:

Inflatable flood protection barriers or antiflood booms are highly effective, quick-deploying booms designed to provide rapid defence against rising water levels during floods. These barriers are crafted from durable, weather-resistant materials and can be swiftly inflated on-site, forming a temporary but reliable wall that prevents floodwaters from spreading. Their flexible design allows for use in various terrains, including urban areas, riverbanks, and coastal regions, making them an ideal solution for emergency situations.



E-mail: contact@econadin.com
WhatsApp Business: +380667404649
Web: www.econadin.com,
www.econad.co.uk





ECONAD

INFLATABLE FLOOD PROTECTION BARRIERS



APPLICATIONS:

- **Flood Prevention:** Provides immediate containment of floodwaters in residential, commercial, and industrial areas.
- **Rapid Deployment:** Suitable for emergency response teams needing fast deployment in flood-prone regions.
- **Water Diversion:** Effective for redirecting or containing water in areas near rivers, lakes, and dams during heavy rainfall.
- **Temporary Protection:** Used for short-term flood defence to protect infrastructure, roads, and buildings.
- **Coastal and Riverbank Protection:** Protects sensitive areas, such as riverbanks, marinas, or coastal zones, from rising tides and flood surges.



E-mail: contact@econadin.com
WhatsApp Business: +380667404649
Web: www.econadin.com,
www.econad.co.uk





JELLYFISH BOOMS

ECONAD is a leading company in ecosystem protection, with nearly 30 years of experience in developing and implementing environmental technologies aimed at safeguarding the natural environment from oil pollution.

The Meduza Net has proven its benefits across various applications, particularly in fishing and beachline protection. Recently, the increasing occurrence of jellyfish invasions along coastlines has made devices that protect the public from these unpleasant encounters highly sought after.

SPECIFICATIONS OF THE MEDUZA BARRIER NETWORK:

- + Prevents jellyfish and algae from passing through
- + Does not have any negative impact on marine life
- + Reduces damage caused by poisonous jellyfish (including material damage)
- + High strength and resistance to damage
- + Easy to assemble

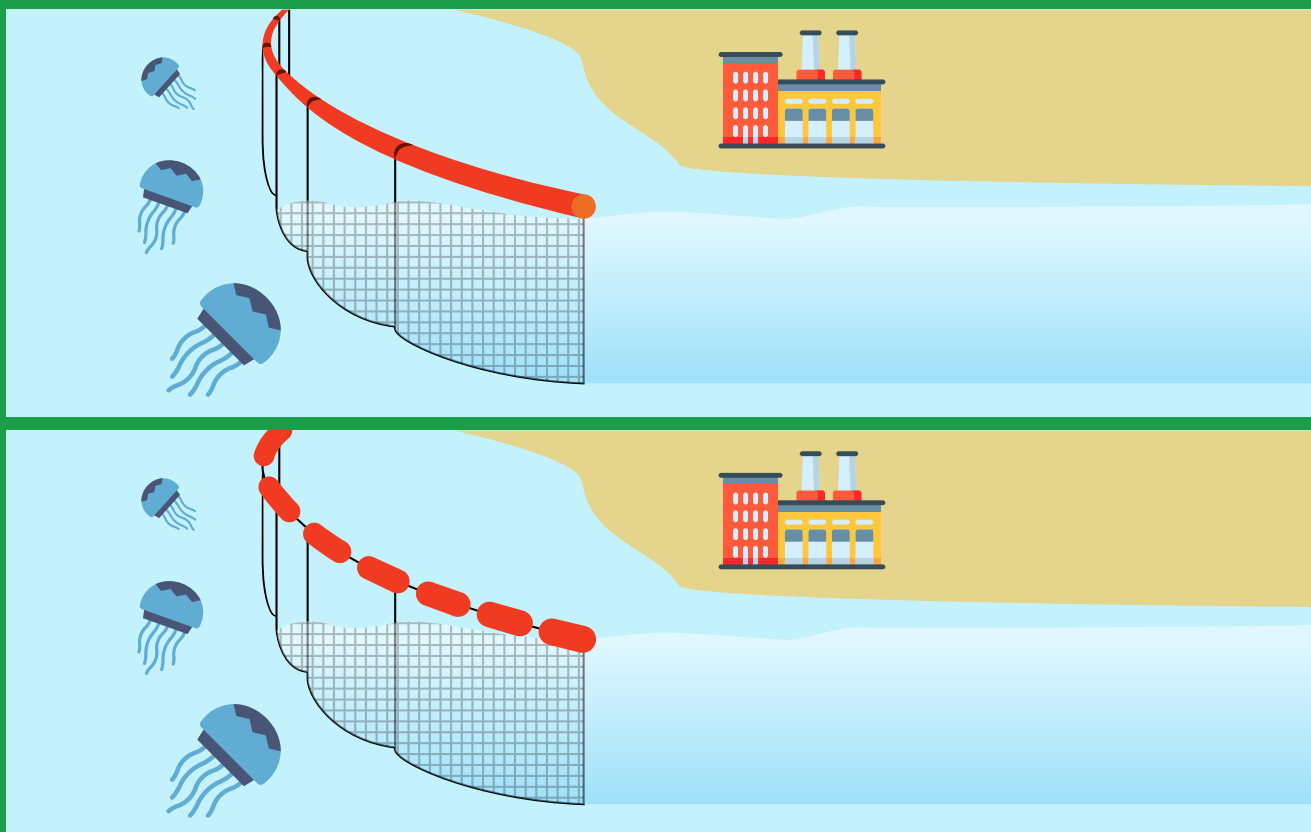

E-mail: contact@econadin.com
WhatsApp Business: +380667404649
Web: www.econadin.com,
www.econad.co.uk





ABSORBENT BOOMS



BIOSORBENT BOOMS

Biosorbent booms "Econad" with biodestructive activity consist of individual sections filled with the hydrophobic and oleophilic biosorbent "Econadin."



Diameter	Length	Sorption container 1pc	Weight 1pc
125mm	1000-2000 mm	6,5l	0.2 kg
125 mm	3000 mm	14l	0.8 kg

They are intended for:

- + Treatment of oily wastewater
- + Use in treatment facilities at the initial stage of purification (e.g., oil-contaminated water reservoirs)
- + Treatment of oil-contaminated wastewater in wastewater treatment plants at the final stage of purification (e.g., settling tanks and collectors)
- + Containment and collection of oil pollution in shallow waters
- + Protection of coastlines from oil pollution
- + Fencing off oil-contaminated areas on land during remediation work

Specifications

Ingredients:	biosorbent "Econadin" / polypropylene fibers
Absorbents:	oil, oil products, coolants, solvents
Color:	black, white

OIL ABSORBENT BOOMS

Absorbent booms "Econad" with hydrophobic polypropylene fiber are specifically designed to collect, localize, and move oil spills on both solid and water surfaces. You can purchase these booms on our website after reviewing the product details.



Specifications

Ingredients:	polypropylene fibers
Absorbents:	oil, oil products, coolants, solvents
Packaging:	8pcs

Diameter	Length	Sorption container 1pc	Weight 1pc
127 mm	3000 mm	24-36 l	2 kg
200 mm	3000 mm	48-54 l	3 kg



E-mail: contact@econadin.com
 WhatsApp Business: +380667404649
 Web: www.econadin.com,
www.econad.co.uk





ABSORBENT BOOMS

ABSORPTIVE MINI-BOOMS

Econadin biosorbent mini-booms are polymer mesh sleeves filled with hydrophobic and oleophilic Econadin biosorbent or polypropylene fibers.



ARE INTENDED FOR:

- + Treatment of wastewater contaminated with oil products
- + Protection of storm sewers
- + Enhancing the quality of industrial wastewater treatment in storm sewer systems

Specifications	
Ingredients:	biosorbent "Econadin" / polypropylene fibers
Absorbents:	oil, oil products, coolants, solvents
Color:	white

Diameter	Length	Sorption container 1pc	Weight 1pc
127 mm	500 mm	5 l	0,4 kg
200 mm	500 mm	8 l	0,5 kg

CHEMICAL ABSORBENT BOOMS

Sorbent boom for collecting chemicals.

Diameter	Length	Sorption container 1pc	Weight 1pc
75-80 mm	1000 mm	3 l	0,2 kg
76 mm	1200 mm	6,5 l	0,4 kg
76 mm	2400 mm	14 l	0,8 kg

Specifications	
Ingredients:	polypropylene fibers + synthetic material
Absorbents:	acids, alkalis, other aggressive chemical substances
Color:	yellow
Packaging:	12pcs



OIL ABSORBENT MINI-BOOMS

Sorption mini-booms are designed to contain small spills on hard surfaces and prevent them from entering storm sewers.

Diameter	Length	Sorption container 1pc	Weight 1pc
75-80 mm	1000 mm	3 l	0,2 kg
76 mm	1200 mm	6,5 l	0,4 kg
76 mm	2400 mm	14 l	0,8 kg

Specifications	
Ingredients:	polypropylene fibers + synthetic material
Absorbents:	oil, oil products, coolants, solvents
Color:	black, white
Packaging:	12pcs



E-mail: contact@econadin.com
 WhatsApp Business: +380667404649
 Web: www.econadin.com,
www.econad.co.uk





ECONAD MARINE SECURITY BOOMS: Unmatched Strength and Durability

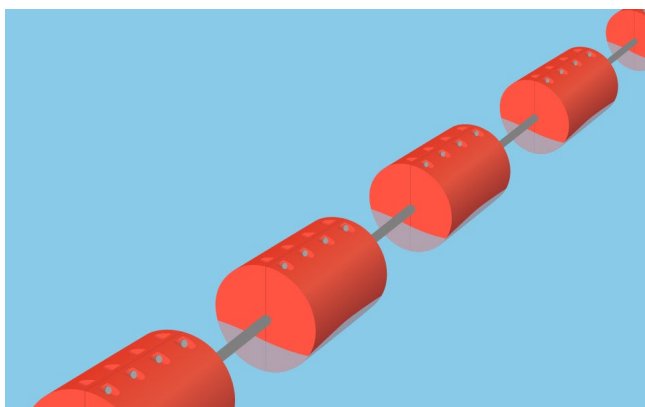
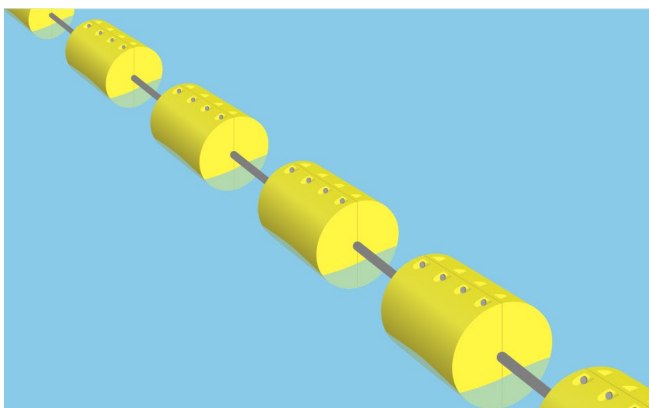

ECONAD Marine Security Booms, particularly our **ORCA 1200/915/770** models, are engineered to perform in the most demanding marine environments. Renowned for their extraordinary strength and long-lasting durability, they are built to withstand the harshest conditions.



E-mail: contact@econadin.com
WhatsApp Business: +380667404649
Web: www.econadin.com,
www.econad.co.uk





ECONAD MARINE SECURITY BOOMS: Unmatched Strength and Durability

The **ORCA 1200/915/770** marine security booms serve a dual purpose, both physically and visually. With integrated spikes (ORCA Protector), they effectively deter medium-sized watercraft, while the optional fence (ORCA SENTINEL) add-on can stop larger vessels in their tracks.



Crafted for turbulent waters, these booms remain buoyant even if the outer shell is damaged. With an impressive break load capacity of 60-80 tons, ECONAD Marine Security Booms are designed to endure any impact.



E-mail: contact@econadin.com
WhatsApp Business: +380667404649
Web: www.econadin.com,
www.econad.co.uk





ECONAD MARINE SECURITY BOOMS: Unmatched Strength and Durability

TECHNICAL SPECIFICATION	ECONAD ORCA 770	ECONAD ORCA 915	ECONAD ORCA 1200
Part No.:	ORCA 770	ORCA 915	ORCA 1200
Diameter:	77cm (30.315in)	91.4cm (36.4in)	120cm (48in)
Length:	120cm (47in)	122cm (48in)	140cm (55in)
Weight (dry):	65kg	102 kgs (225lbs)	130kgs (286lbs)
Buoyancy:	420kg (925lbs)	680kgs (1500lbs)	870kgs (1918lbs)
Freeboard:	56cm (22.14in)	73cm (29in)	90cm (35.4in)
Design Strength:	69,000 kgs (152 kips)	74,000kgs (163kips)	78,000 kgs (171kips)
Internal Construction:	140mm*75mm I-beam	101mm (4in) steel tube	152.4mm (6in) steel tube
EPS:	Foam Fill	Foam Fill	Foam Fill
Wall Thickness (nom):	6-8 mm (0,25-0,31in)	6mm (0.250in)	6mm (0.250in)
Material:	LLDPE	LLDPE	LLDPE
Color:	Red/Yellow	Red/Yellow	Red/Yellow
Connection:	Steel cable / Rope / Cable loop etc		
Attention:	There are foamed and have steel channel and antirotation system inside		





BARRIERS (ECONAD-FENCE)

Barriers are equipped with a special steel axis, which is used to distribute the load throughout the barrier system.



ECONAD-FENCE FLOATS HAVE THE FOLLOWING SIZE VARIATIONS:

- 30 cm in diameter and 70 cm in length,
- 40 cm in diameter and 70 cm in length,
- 60 cm in diameter and 100 cm in length,
- 90 cm in diameter and 120 cm in length.



E-mail: contact@econadin.com
WhatsApp Business: +380667404649
Web: www.econadin.com,
www.econad.co.uk





ECONAD

BARRIERS (ECONAD-FENCE)

The barrier has a draft of 50 to 125 mm, which means that 87% of the barrier is always in sight. It also provides buoyancy, barriers, which, depending on the model of the float, varies from 45 to 760 kg.

The barrier shell is made of extremely high quality and UV resistant polyethylene. This material has exceptional strength and durability, so this barrier can be used for many years without fear of damage or tearing.

The main axis of each Econad-Fence section is 100% welded stainless steel or galvanized steel that is corrosion resistant. The type of steel is selected depending on the application.



E-mail: contact@econadin.com
WhatsApp Business: +380667404649
Web: www.econadin.com,
www.econad.co.uk

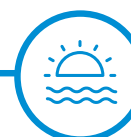

BARRIERS TO GUARD FACILITIES

These security booms are designed for permanent year-round operations. They are ideal for nearshore applications, waterways, marinas and private water bodies.

Barrage booms for the protection of water bodies from Econad are specialized barriers that perfectly cope with the task of protecting water bodies. They represent a steel base with fixed bunnings and special steel spikes that are installed around the entire perimeter of the barrier.

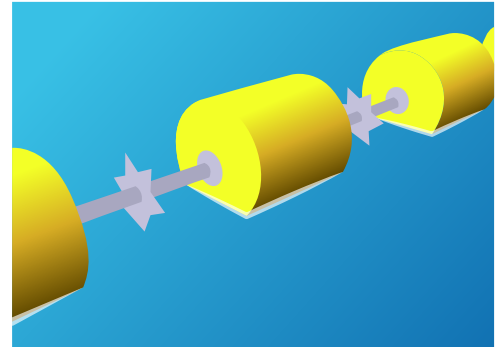

Protection of water bodies – activities aimed at the conservation and restoration of water bodies. This activity extends both to the water bodies themselves and to their water protection zones. In addition, specially protected water bodies are distinguished, including those of international importance. In order to protect water bodies used for drinking and domestic water supply, as well as those containing natural healing resources, zones and districts of sanitary protection are established.

Benefits

- 1. Proven Protection:** The booms are designed with a tubular backbone, providing immense strength and capable of handling loads exceeding 50 tons.
- 2. Unsinkable Design:** The internal closed-cell polyurethane foam ensures that the float maintains full buoyancy, even in the unlikely event of damage to the outer float skin due to heavy collisions, making the booms virtually unsinkable.
- 3. UV-Resistant Material:** The high-quality material used for the outer skin is highly resistant to UV light and color fading over time, making it ideal for use in environments with high UV exposure.

Optional Extras

Upon request, «Econad» company is able to offer supervision of assembly, installation and maintenance.

We can also offer demarcation lighting for additional safety at night.

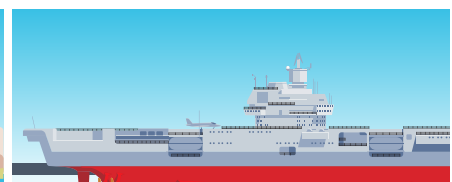
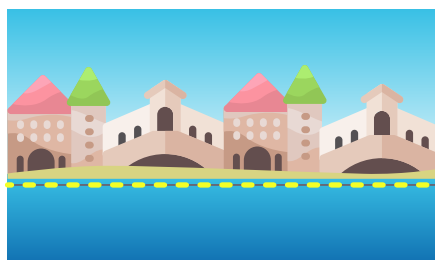
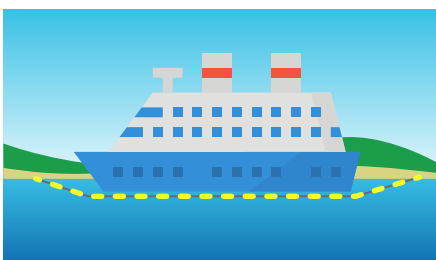

E-mail: econadin@ukr.net
contact@econadin.com
Skype: econad.sie
Web: www.econadin.com, www.econad.com.ua

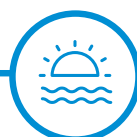



BUOYS, FLOATS

FOR SLURRY PIPELINES

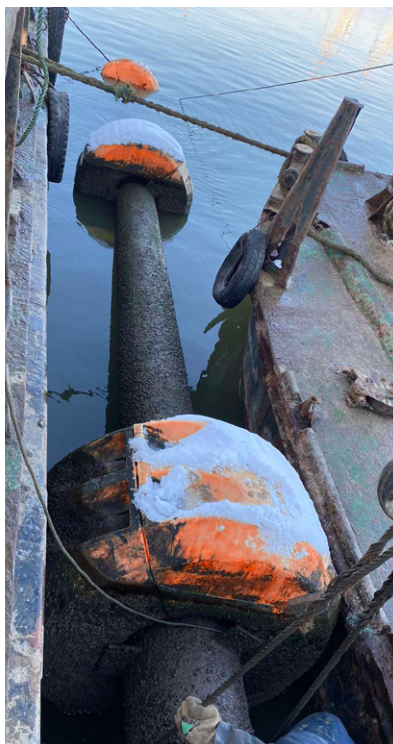
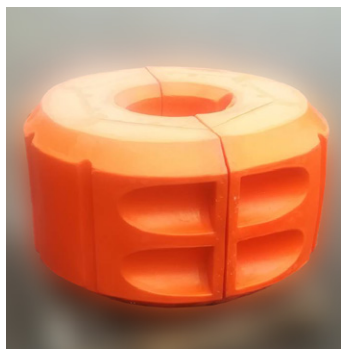

Don't know how to support slurry pipeline pipes on water? Or do you just want floating carriers that are easy to use? Then floats for slurry pipelines are what you need!

What is a float for slurry pipelines?

As you know, a slurry pipeline is a pipeline used to transport pulp from a dredger or other hydraulic equipment to a discharge point. The floating slurry pipeline is designed to connect the operating dredger to the onshore slurry pipeline. It allows for working maneuvering, serves as a supporting structure for fastening power and control cables, moving personnel to the dredger or to the shore.

Indispensable floats!

The installation of floating slurry pipelines is carried out on special floats, the number of which depends on the length of the slurry pipelines!

What are floats used for?



E-mail: contact@econadin.com
WhatsApp Business: +380667404649
Web: www.econadin.com,
www.econad.co.uk





BUOYS, FLOATS

FOR SLURRY PIPELINES

Versatility and durability!

The body of the float is made of medium density polyethylene, inside the float is filled with a high-strength polyurethane foam backing. Floats for slurry pipelines from EcoNad will be an ideal replacement for traditional steel floats.

The floating body of the float is durable, equipped with shock and wave resistance. The floats are easy to install and operate, light in weight and reasonably priced.

Working temperature from -40°C to $+60^{\circ}\text{C}$, they are also resistant to UV radiation, which is a must when installing floats on water!

WE PRODUCE POLYETHYLENE FLOATS:

- + to support the pipe of the slurry pipeline on the water;
- + to use our floats as floating carriers for any purpose.

SCOPE OF APPLICATION:

Slurry line floats are used in dredging sand pipelines;

They can be used in the sea, lake or river;

Convenient for use when laying pipes on water.



E-mail: contact@econadin.com
WhatsApp Business: +380667404649
Web: www.econadin.com,
www.econad.co.uk





ECONAD

OIL TUBE SKIMMERS

Oil tube skimmers – mechanical equipment for removing oil, grease and oil products from the surface of water, coolants, emulsions, washing solutions, wastewater.



Working Principle of Tube Skimmers for Collecting Oil Products:

Oil, grease, and oil products floating on the liquid surface adhere to the outer surface of a special collector tube. This tube, along with the collected oil and grease, is drawn into the oil trap. The oil skimmers then remove the contaminants from the surface of the collector tube, ensuring efficient clean-up of the oil products.

THESE SKIMMERS ARE USED FOR:

- sewage tanks (settlers);
- oil receiving wells;
- separators;
- circulating systems for washing parts and assemblies;
- grease traps of food production and enterprises total. food;
- industrial sedimentation tanks, sludge pits;
- heat treatment equipment;
- washers and washing parts;
- cleaning coolant from free oil.



E-mail: contact@econadin.com
WhatsApp Business: +380667404649
Web: www.econadin.com,
www.econad.co.uk



**ECONAD**

OIL TUBE SKIMMERS

Model.	XENA SKM 500	XENA SKM 240	XENA SKM 50
Productivity, l/h.	up to 500	up to 240	up to 50
Collector tube, mm	ø21.5	ø21.5	ø18
Power consumption, W	180	180	120-180
Power supply, V	230/1-phase – 400/3-phase	230/1-phase – 400/3-phase	230/1-phase – 400/3-phase
Drainage pipe, mm	ø63	ø63	ø25 (outside), ø22 (inside)
Operating temperature, °C	-20/+90	-20/+90	-20/+90
Size of the skimmer body, mm	500x250x290	500x250x290	500x250x290
Weight, kg	up to 16.5	up to 16.5	up to 10.5
Button (on/off)	is	is	is
Fasteners	“Easy mounting” with 2 bolts. Rack with magnet (optional)		
Special equipment	timer (optional)		

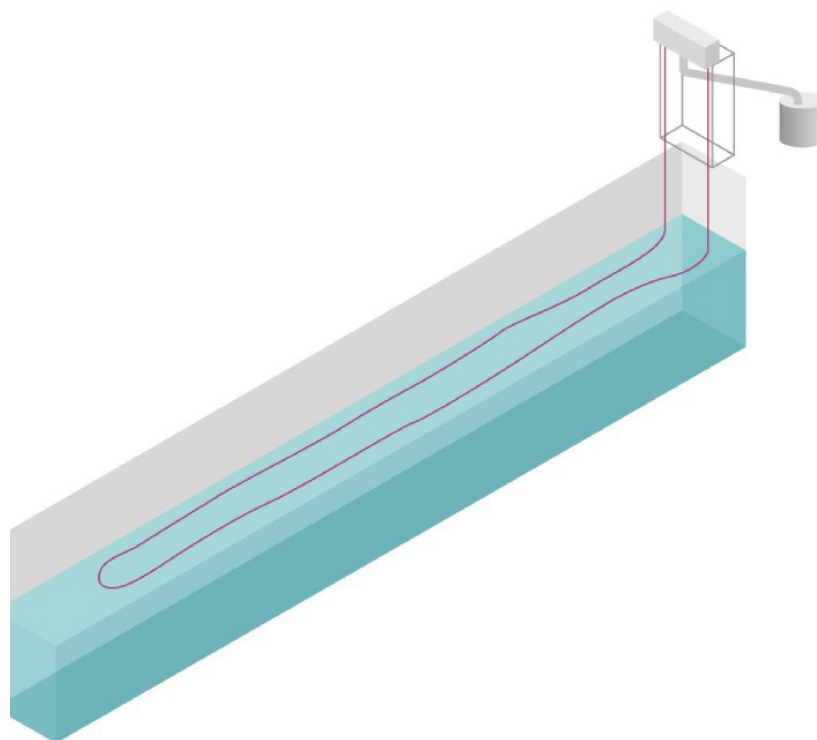

E-mail: contact@econadin.com
 WhatsApp Business: +380667404649
 Web: www.econadin.com,
www.econad.co.uk





ECONAD

OIL BELT SKIMMERS

BELT SKIMMER — mechanical equipment used for removing oil, grease, and oil products from the surface of water, coolants, emulsions, washing solutions, and wastewater.

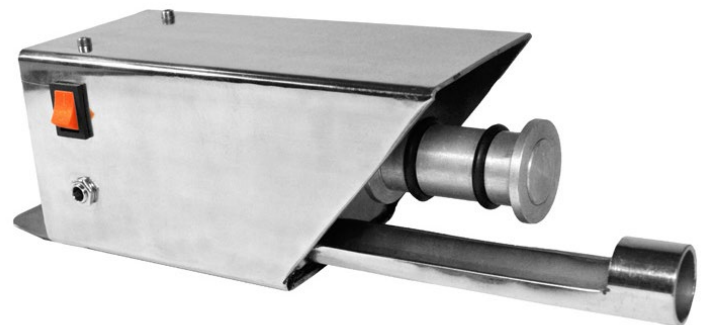

Operating Principle of a Portable Belt Tramp Oil Skimmer for Collecting Oil Products:

Oil, grease, and oil products floating on the liquid surface adhere to the outer surface of a special collector belt. This collector belt, along with the attached oil and grease, is drawn into the oil trap. The skimmer's oil scrapers then remove the contaminants from the surface of the collector belt.

OIL SKIMMER APPLICATIONS:

- Sewage tanks (settling tanks)
- Oil receiving wells
- Separators
- Circulating systems for washing parts and assemblies
- Grease traps in food production and catering facilities
- Industrial sedimentation tanks and sludge pits
- Heat treatment equipment
- Parts washers and cleaning systems
- Cleaning coolant from free oil



E-mail: contact@econadin.com
WhatsApp Business: +380667404649
Web: www.econadin.com,
www.econad.co.uk





ECONAD

OIL BELT SKIMMERS

THE BENEFITS OF USING:

- this is the most economical way to collect oil/fat/petroleum products from the water surface;
- do not require any operating costs other than electricity (6 W/h);
- these are powerful and reliable skimmers;
- have high performance;
- the ability to install anywhere and in different conditions.

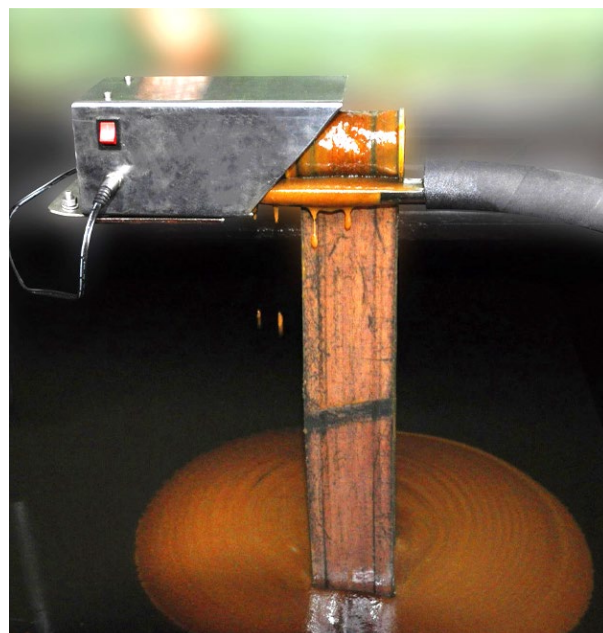

E-mail: contact@econadin.com
WhatsApp Business: +380667404649
Web: www.econadin.com,
www.econad.co.uk



**ECONAD**

OIL BELT SKIMMERS

Model	SKM 3	SKM 6	SKM 10	SKM 20	SKM 50
Productivity, l./h.	to 3	to 6	to 10	to 20	up to 50
Width of the tape, mm	50	70	120	120	ø18
Energy consumption, W	6	6	6	6	120-180
Food, V	230	230	230	230	230/1phase – 400/3phase
Sewage drainage pipe, mm	ø25(outside), ø22(inside)	ø25(outside), ø22(inside)	ø25(outside), ø22(inside)	ø25(outside), ø22(inside)	ø25(outside), ø22(inside)
Maximum liquid temperature, °C	90	90	90	90	-20/+90
Size of the skimmer body, mm	80x80x255	80x80x255	100x100x350	100x100x350	500x250x290
Weight, kg	2.6	2.8	3.8	4.8	to 10.5
(on/off) button	is	is	is	is	is
Attachment	“Easy mounting” using 2 bolts. Stand with a magnet (optional)				
Special equipment	timer (optional)				



E-mail: contact@econadin.com
 WhatsApp Business: +380667404649
 Web: www.econadin.com,
www.econad.co.uk

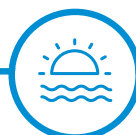
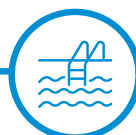



DISC SKIMMER "XENA"

The XENA disc skimmer is a floating device for collecting oil and oil products of various viscosities from the water surface. It is possible to collect both petroleum products and organic oils.

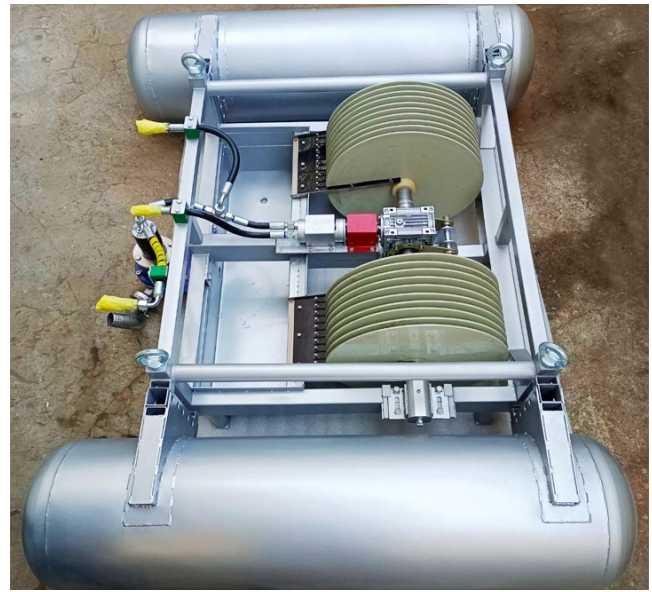

Peculiarities:

The performance of the skimmer can be adjusted depending on the situation and tasks.

It can work both in the port water area and in the coastal zone.

PRINCIPLE OF WORK:

Oil products adhere to the outer surface of the rotating drum or discs, which are constructed of PVC material, aluminum or steel. The discs rotate thanks to a hydraulic (or electric) motor.

The oil products are then mechanically removed using scrapers. From the oil sump, the collected contaminants are pumped out by a pump located on the shore or on the ship. The kit may include an arrow with barrage booms.



E-mail: contact@econadin.com
WhatsApp Business: +380667404649
Web: www.econadin.com,
www.econad.co.uk





ECONAD

DISC SKIMMER "XENA"

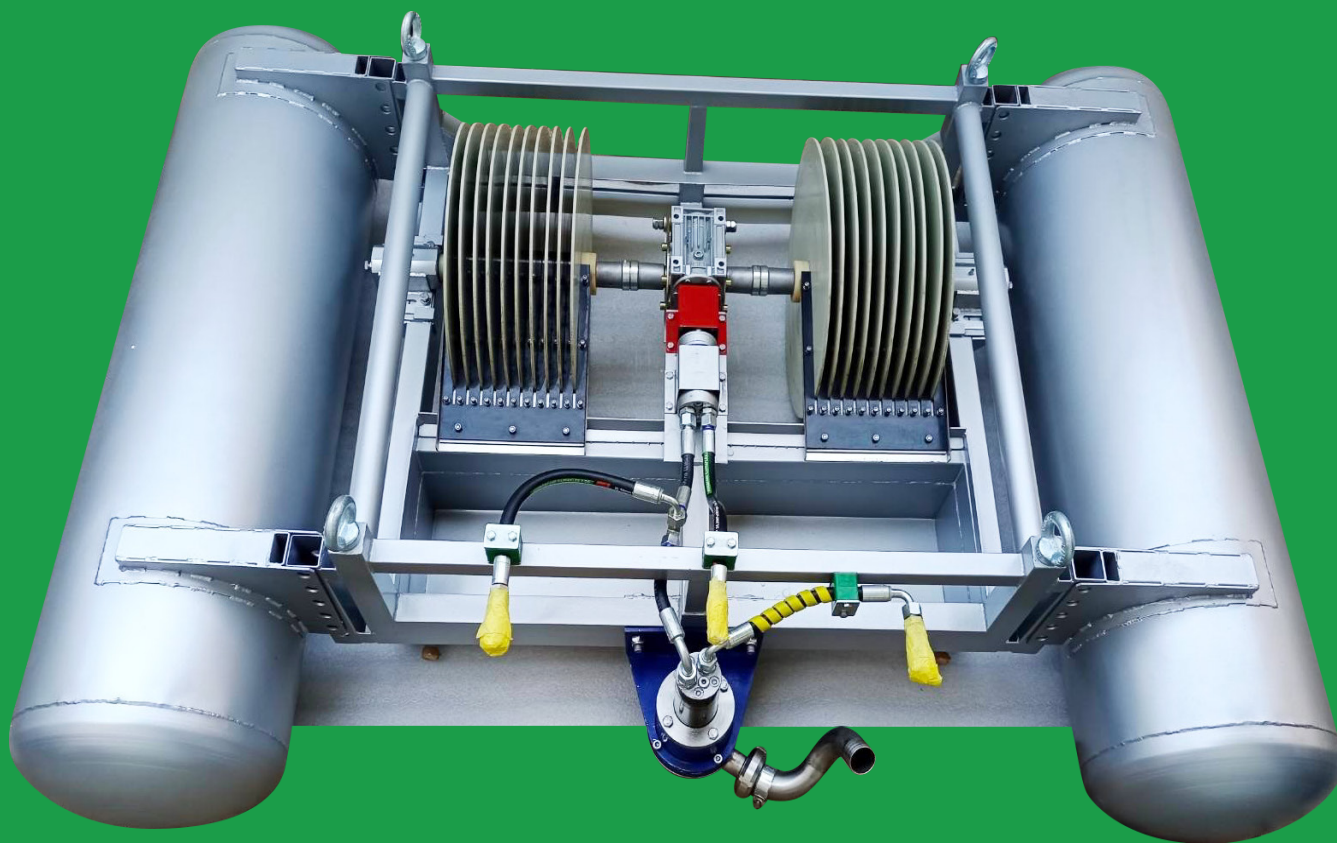

Type	XENA 5	XENA 15	XENA 20	XENA 30	XENA 60
Productivity, m ³	1-5	10-15	15-20	20-30	30-60
Dimensions, l/w/h, mm	770x750x350	845x673x420	1100x1100x550	1325x1100x570	1650x1650x700
Weight, kg	53	72.5	85	100	125
Draft, mm	105	110	110	120	120
Sleeve diameter	ø2	ø2	ø3	ø3	ø3



E-mail: contact@econadin.com
 WhatsApp Business: +380667404649
 Web: www.econadin.com,
www.econad.co.uk





WEIR SKIMMER "AQUA"

Weir skimmers of the AQUA model are floating devices designed to collect oil and oil products of varying viscosities from the surface of port waters, calm rivers, floodplains, artificial reservoirs, and swamps.



AQUA skimmers can be installed with booms during OSR operations. Also intended for stationary use in sedimentation tanks, tanks.



E-mail: contact@econadin.com
WhatsApp Business: +380667404649
Web: www.econadin.com,
www.econad.co.uk





WEIR SKIMMER "AQUA"

OPERATING PRINCIPLE:

A pump driven by a hydraulic station with a continuously adjustable hydraulic flow allows you to adjust the thickness of the pumped oil film layer. The performance of AQUA skimmers depends on the performance (power) of the pumped out device.

Type	AQUA 10	AQUA 20	AQUA 30
Capacity, m ³	1-10	10-20	20-30
Dimensions, d/w/n,mm	770x750x350	985x1080x530	1125x1100x570
Weight, kg	15,5	20,5	22
Draft, mm	310	310	320
Free water capture, %	<5	<5	<5
Hydraulic pressure, bar	60-100	60-100	60-100
Power, kW	0,3	0,3	0,3
Sleeve diameter	ø38	ø50	ø76





DRUM SKIMMER "OILX"

The OILX drum skimmer is a floating device for collecting oil and oil products of varying viscosity from the water surface.



PRINCIPLE OF OPERATION:

With the help of rotating drums, oil products are collected from the surface of the water by sticking to the surface of the drum and discharged into a container tightly attached to the skimmer.



E-mail: contact@econadin.com
WhatsApp Business: +380667404649
Web: www.econadin.com,
www.econad.co.uk





DRUM SKIMMER "OILX"

FEATURES OF THE SKIMMER:

When creating the skimmer OILX, special aluminum alloys are used in the design, resistant to the aggressive marine environment. Replaceable cartridges allow you to work effectively with various types of oil products and with virtually any thickness of oil contamination. As a drive for skimmers OILX, a hydraulic station from an internal combustion engine is used.

DIMENSIONS:

Length	2.3 m
Width	2.0 m
Height	1.1 m
Power	500 W



E-mail: contact@econadin.com
 WhatsApp Business: +380667404649
 Web: www.econadin.com,
www.econad.co.uk





VACUUM OIL COLLECTION SKIMMER

The Vacuum Skimmer ECONAD VC350 is designed for the mechanized vacuum collection of oil (petroleum products) spilled on soil, solid surfaces, and water. It is also suitable for cleaning oil tanks, settling tanks, reservoirs, pits, and evaporators.



Principle of operation:

The mechanism of operation is quite simple: the device is equipped with a capacity of 75-600 liters, which has a special nozzle for collecting spilled oil (petroleum products). The nozzle is brought to the surface requiring cleaning, after which the vacuum pump is turned on, powered by a gasoline or diesel internal combustion engine. A negative pressure of 0.5 atmosphere is created in the tank, under the influence of which oil enters the cylinder. When the cylinder is full, the device switches to the unloading mode, while positive pressure can be created in the tank or oil flows out by gravity through the hose connected to the tank.



E-mail: contact@econadin.com
WhatsApp Business: +380667404649
Web: www.econadin.com,
www.econad.co.uk





VACUUM OIL COLLECTION SKIMMER

Technical specifications	The Vacuum Skimmer ECONAD VC350
Capacity max, m.cu./h	up to 20
Equipment	Power unit (engine/pneumocompressor or diesel generator) Pump transporting collected oil products with drive from the engine Hose for pumping oil products (not less than 10 m) Collection tank and removable nozzles Valve excluding vacuum when filling tanks.
Gross weight, kg	Up to 200
Capacity of one load, l	300
The occasion	Hydraulic/electric
Power	Up to 9 kW
Voltage	380V,3 phases
Pump type	self-priming
Suction column height, m	5
Hose diameter, k	Ç2
Overall dimensions	2.5 m ³
Year of manufacture	2019

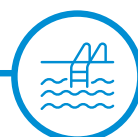



SKIMMER "DELTA"

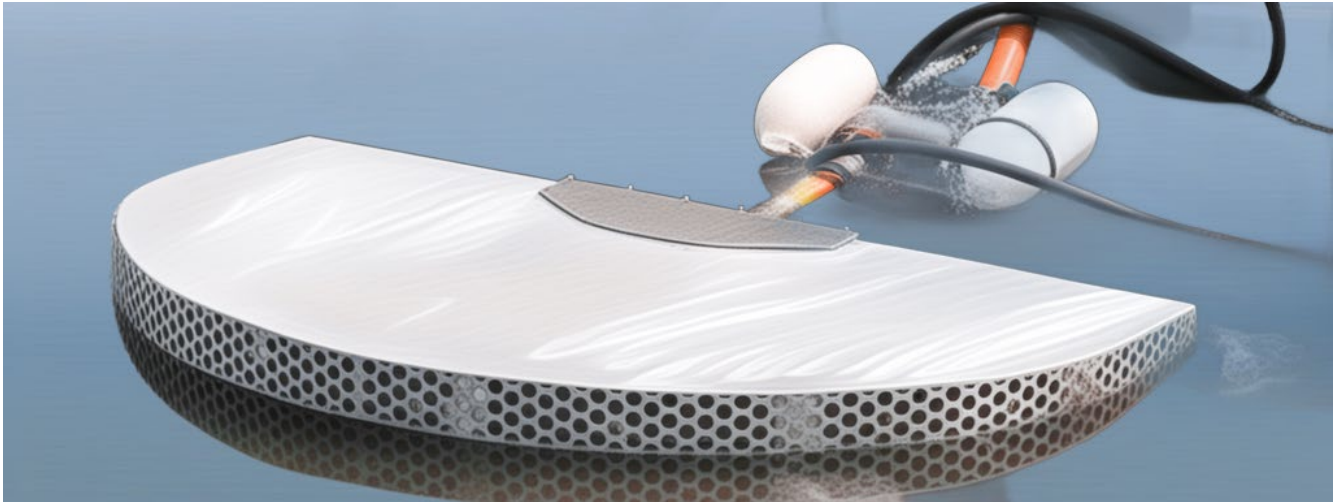

ECONAD's Delta skimmer for pumping oil products and lubricants in shallow water and on the river is a strong and lightweight device that is ideal for places where the use of large skimmers is impossible or ineffective.

This shallow water oil and oil skimmer consists of a free-floating skimmer float capable of removing up to 30 tonnes per hour, depending on pump/oil product type and viscosity.

The floating skimmer module "Delta" is suitable for any aspiration pump or vacuum installation. It is easy to control and easy to use, and can work in hard-to-reach places, such as under bridges or around piers.



E-mail: contact@econadin.com
WhatsApp Business: +380667404649
Web: www.econadin.com,
www.econad.co.uk





ECONAD

SKIMMER "DELTA"

The skimmer module can work at a depth of 7 cm, which makes it ideal for cleaning rivers, lakes and other bodies of water with a shallow depth.

The lightweight design makes the shallow pump oil skimmer particularly useful for cleaning beaches, rivers and other coastal areas, as well as in ports, harbors and other water bodies.

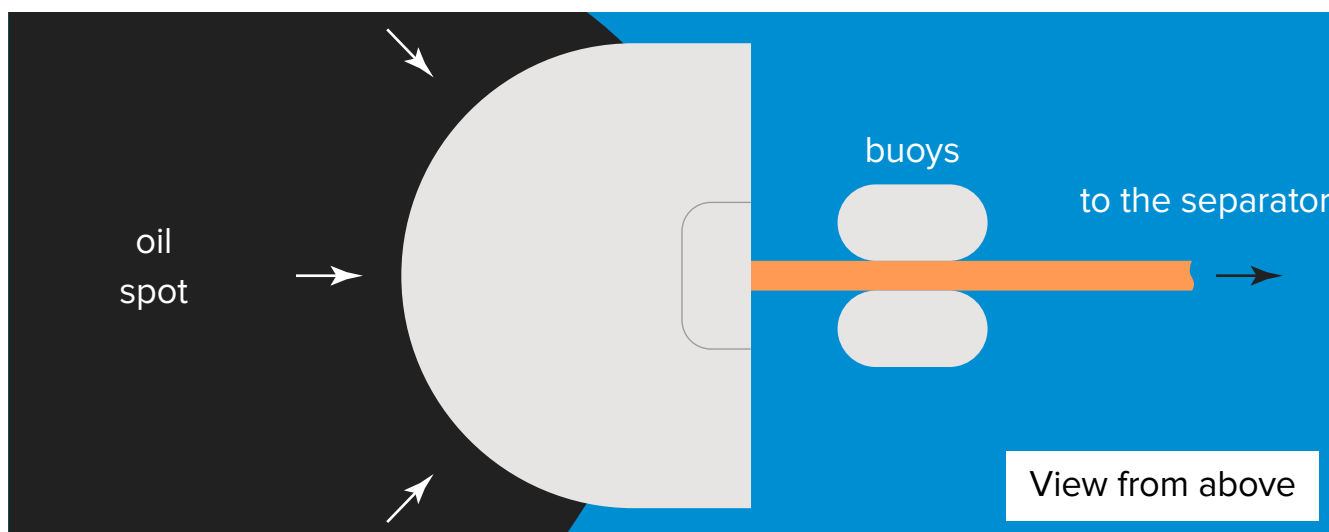
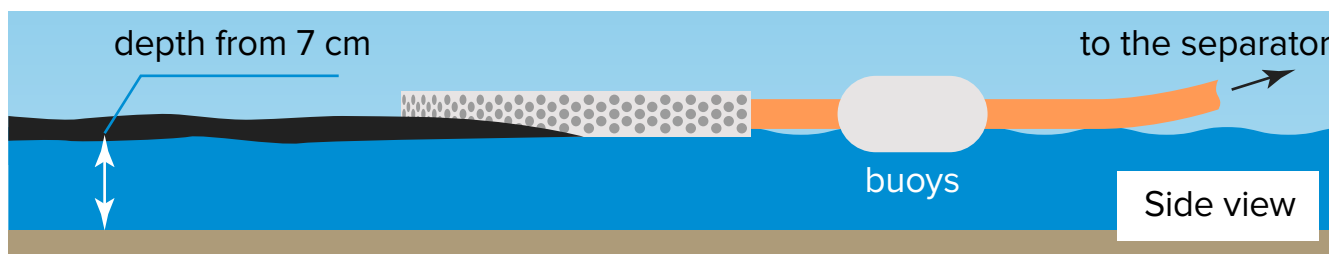
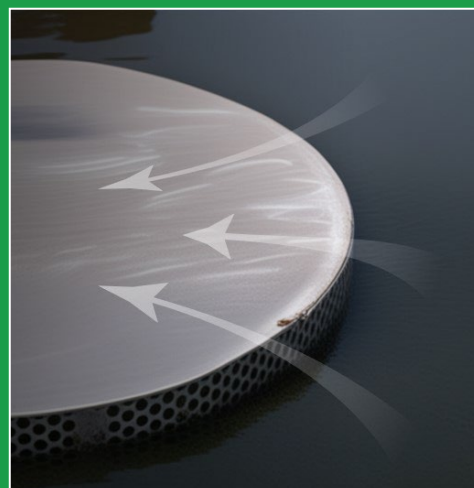

E-mail: contact@econadin.com
WhatsApp Business: +380667404649
Web: www.econadin.com,
www.econad.co.uk





SKIMMER "DELTA"

THE PACKAGE INCLUDES:

- a floating platform for collecting oil products from the surface of the water,
- pumping pump,
- a system of hoses for pumping out oil products (up to 10 meters),
- rough cleaning separator with belt oil/oil skimmer SKM3,
- a system of buoys to maintain buoyancy,
- automatic control panel.

SEPARATOR OPERATION

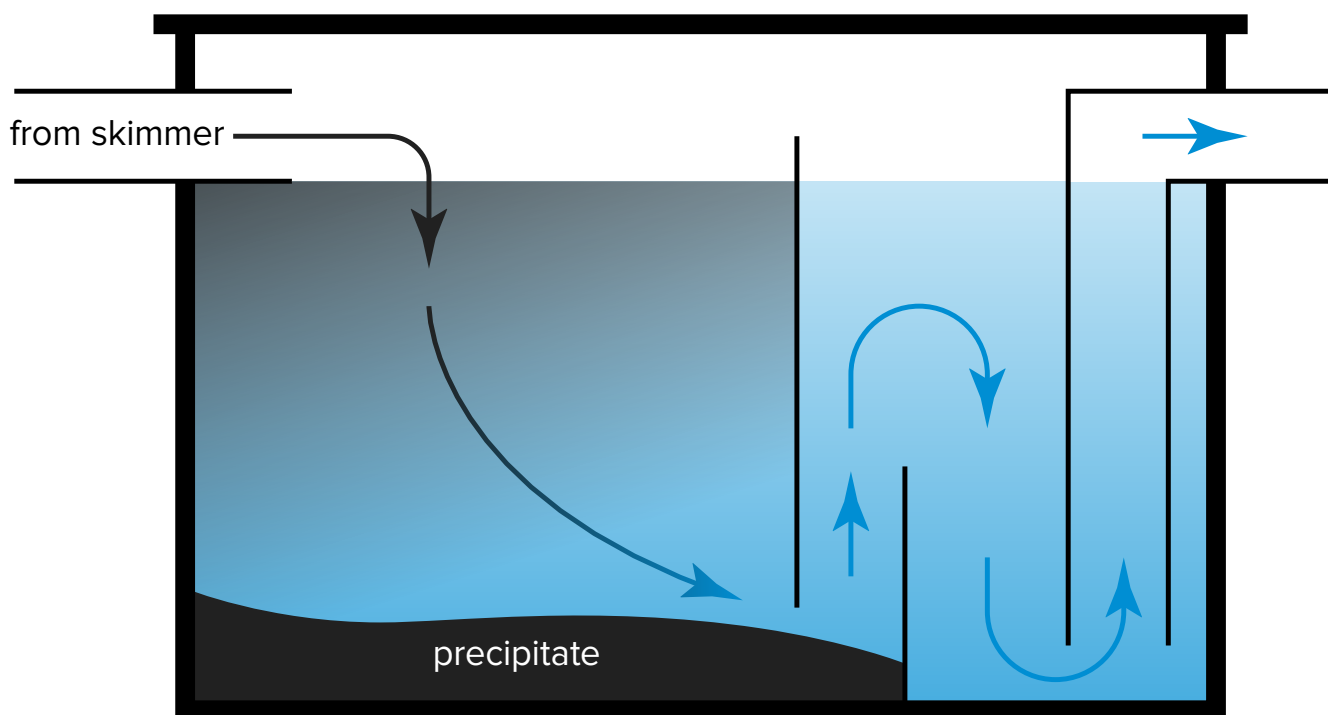

E-mail: contact@econadin.com
WhatsApp Business: +380667404649
Web: www.econadin.com,
www.econad.co.uk





HINGED SKIMMER "LE GRANDBRAS"

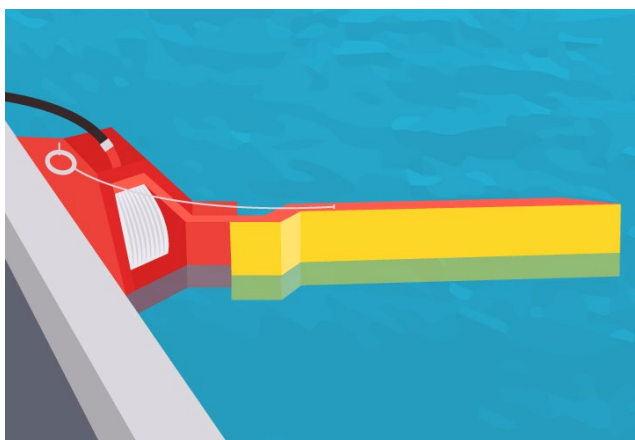
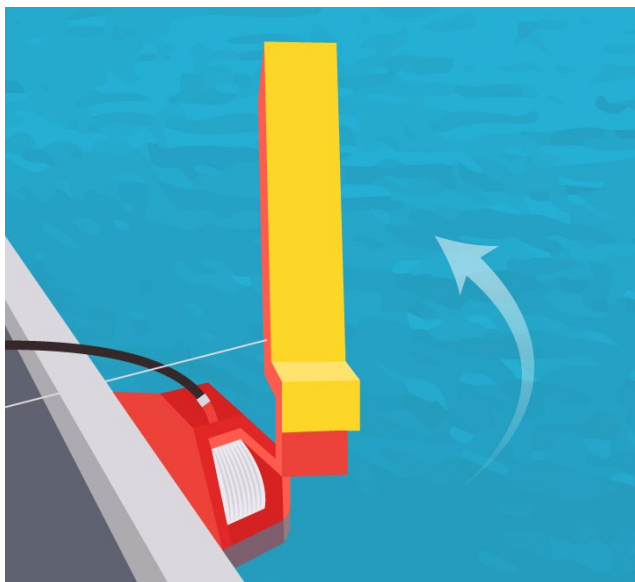

Le GrandBras - is a highly efficient and economical tool for rapid response to local oil spills in coastal areas, lakes, and ports. This innovative equipment is designed to maximize efficiency and optimize resource usage during emergency situations.

Le GrandBras is capable of collecting both heavy and light oils with exceptional efficiency. By using Le GrandBras, even diesel fuel can be collected from the water surface with the aid of any watercraft. It allows for quick and safe elimination of spill consequences, maintaining ecological balance and protecting water resources.

Strong aluminum portable construction Le GrandBras equipped with a wheel at the end that makes the process collection oil products with walls berths and sides of ships still simpler and more effective. Thanks to this Le GrandBras is indispensable a tool for ports, sea and river transportation, as well as for environmental services and companies that are engaged in liquidation spills oil.



E-mail: contact@econadin.com
WhatsApp Business: +380667404649
Web: www.econadin.com,
www.econad.co.uk





Smart Bin

FLOATING ASSEMBLY DEVICE FOR FLOATING GARBAGE

The SmartBin design is equipped with hoses and a high-capacity motor pump, allowing water to be pumped into the SmartBin and then back to the pool.

Once the water is in the SmartBin, it passes through a special collector filter that efficiently separates garbage, such as debris, plastic packaging, etc. These items can then be recycled and reused.

SmartBin Features Based on Threshold Skimmer Technology:

- + SmartBin can collect 5 to 20 kg of debris (depending on the size and form of the garbage).
- + Operates on 220V power supply.
- + Collected waste can be recycled.
- + The set includes a motor pump for operation.

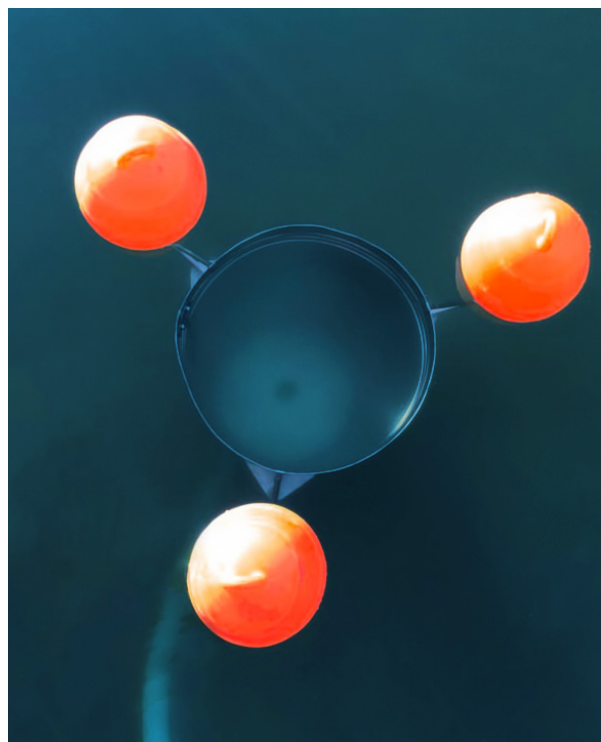

SmartBin collects the following types of garbage:



E-mail: contact@econadin.com
WhatsApp Business: +380667404649
Web: www.econadin.com,
www.econad.co.uk





Smart Bin

FLOATING ASSEMBLY DEVICE FOR FLOATING GARBAGE

ADVANTAGES OF SMARTBIN APPLICATIONS:

- + High throughput
- + Reliability
- + Easy to use

The SmartBin is installed near berths. Its structure efficiently collects floating debris on the water's surface, automatically accumulating it.

Additionally, certain modifications of the SmartBin are designed to capture waste that may drift within the water area, providing an effective solution for maintaining cleanliness near port facilities.

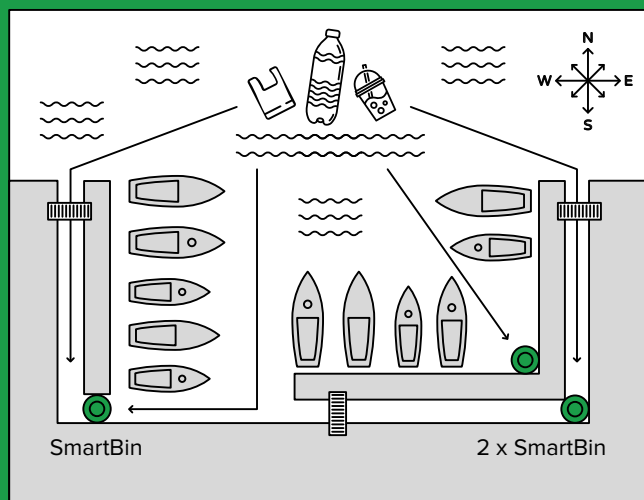

SmartBin is intended for cleaning surface water from debris and is suitable for use in:

- + Marine areas
- + Backwaters
- + Pools
- + Yacht clubs
- + Grain and coal terminal areas

SmartBin + not only collects garbage but also captures coal and grain dust, as well as other fine particles from the surface of the water. In this case, SmartBin is equipped with special filters designed for dust collection. This innovative device helps keep ports and surrounding environments cleaner and more attractive, providing the harbor with a significant "Ecological Boost."

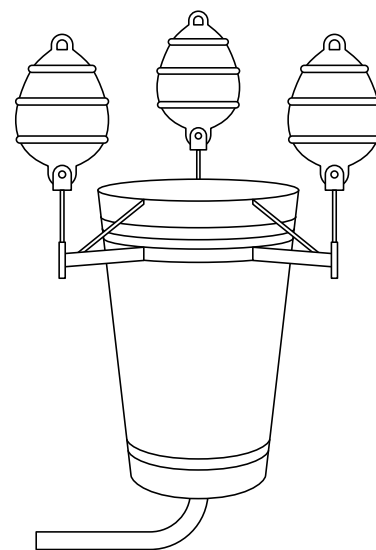
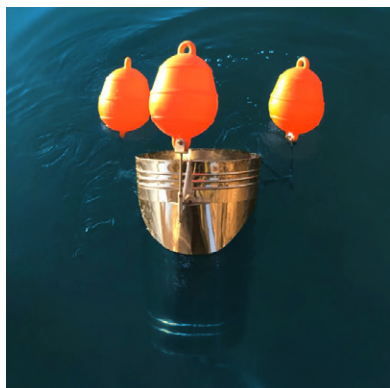

E-mail: contact@econadin.com
WhatsApp Business: +380667404649
Web: www.econadin.com,
www.econad.co.uk





OIL SPILL KITS "ECONAD"

Oil Spill Kit – A lightweight, compact, and mobile set of tools essential for the rapid and effective collection of spilled oil products. Designed for quick response to oil spills, ensuring high-quality cleanup and minimizing environmental impact.

"Ecological Kits" Offer:

- + Elimination of accidental spills and oil leaks
- + Fast collection of spilled oils from surfaces, soil, asphalt, or concrete floors
- + Prevention of oil entering storm sewers
- + Vessels
- + Transport companies for the storage of petroleum products, filling stations, parking lots, and garages
- + Other facilities where petroleum products are used



CHEM SPILL KIT, 55 L



Use area:
elimination of chemical pollution

Absorbate:
acids and alkalis

Absorptive capacity:
55 L

Size:
60 x 40 x 30 cm

CHEM SPILL KIT, 75 L



Use area:
elimination of chemical pollution

Absorbate:
acids and alkalis

Absorptive capacity:
75 L (~1/2 BARREL)

Size:
75 x 60 x 47 cm

CHEM SPILL KIT, 154 L

Use area:
elimination of chemical pollution

Absorbate:
acids and alkalis

Absorptive capacity:
154 L (~1 BARREL)

Size:
60 x 70 x 104 cm



E-mail: contact@econadin.com
WhatsApp Business: +380667404649
Web: www.econadin.com,
www.econad.co.uk

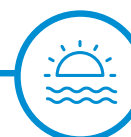



ECONAD

OIL SPILL KITS "ECONAD"

OIL SPILL KIT 1/7/12 BARREL

Use area:
ships, oil terminals, port facilities

Absorbate:
mineral oil, oils, cutting oils, solvents

Absorptive capacity: 154 L (~1 BARREL) /
1120 L (~7 BARREL) / 1920 L (= 12 BARREL)

Size:
94 x 55 x 55 cm



OIL SPILL KIT "MARINE LINE", 55 L



Use Area:
ships, oil terminals, port facilities.

Absorbate:
mineral oil, oils, cutting oils, solvents

Absorptive capacity:
55 L (~1/2 BARREL) of petroleum.

Size:
57 x 39 x 35cm

TRUCK LINE

Use area:
vehicles, vessels, railway transport.

Absorbate:
petroleum, oils, cutting fluids, solvents, petroleum products.



"UNIVERSAL"



Use area:
Vehicles, ships, railway transport.

Absorbate:
mineral oil, oils, coolants, solvents, petroleum products.

Absorptive capacity:
55 L (~1/2 BARREL) of petroleum.

Size:
60 x 40 x 30 cm

"PETROL STATION LINE", 75 L / 154 L



Area of use:
gas stations, service stations, ships, enterprises

Absorbate:
mineral oil, oils, cutting oils, solvents, petroleum products.

Absorptive capacity:
75 L (~1/2 BARREL) of petroleum products.

Size:
75 x 60 x 47 cm.



E-mail: contact@econadin.com
WhatsApp Business: +380667404649
Web: www.econadin.com,
www.econad.co.uk





OIL SPILL KITS "ECONAD"

UV STABILISED HIGHLY VISIBLE, WATER PROOF CONTAINER



Size: 60*65*100cm
Volume: 120ltr
Packing Weight (Gross): 34kg
Color: Green

CONTENTS INCLUDE:

1. Container Green,
2. Absorbent «Econadin» 50ltr,
3. Absorbent Socks, 6 pcs
4. Absorbent Sheets (pads) - 50pcs
5. Disposal Bag, package
6. Absorbent Cushions, 4 pcs
7. Instructions & Contents Card.

OIL SPILL KIT UNIVERSAL



Size: 55*40*30cm
Volume: 80ltr
Packing Weight (Gross): 11,5kg
Color: Yellow

CONTENTS INCLUDE:

1. Shoulder Bag,
2. Absorbent «Econadin» 20ltr,
3. Absorbent Socks, 4 pcs
4. Absorbent Sheets (pads) - 40pcs
5. Disposal Bag, package
6. Instructions & Contents Card.

OIL SPILL KIT UNIVERSAL



Size: 50*40*20cm
Volume: 40ltr
Packing Weight (Gross): 6kg
Color: Yellow

CONTENTS INCLUDE:

1. Kit Shoulder Bag,
2. Absorbent «Econadin», 10ltr,
3. Absorbent Socks, 2 pcs
4. Absorbent Sheets (pads) - 25pcs
5. Disposal Bag, package
6. Instructions & Contents Card.





ECONAD

OIL ABSORBENT MATERIALS

OIL ABSORPTIVE PAD (FOR COLLECTING OIL, OILS AND PETROLEUM PRODUCTS)

Composition: polypropylene / polypropylene + synthetic material

Absorbent substances: oil, oil products, coolants, solvents

Color: white

Reuse: 50%

Packing: 16 pcs.



The size	500x400x9 mm	500x400x9 mm	200x350x60 mm	350x450x100 mm	1000x800x50 mm
Absorbent capacity (100 pieces)	288l	298l	360l	600l	1000l
Weight of 1 (one) mat	0,1kg	0,15kg	0,2kg	0,6kg	1,6kg

DRUM SORBING COVERS (FOR OIL, OILS AND PETROLEUM PRODUCTS)

Composition: polypropylene / polypropylene + synthetic material

Absorbable substances: oil, oil products,

Coolant, solvents

Color: White, Black

Reuse: 50%

Packing: 16 pcs.

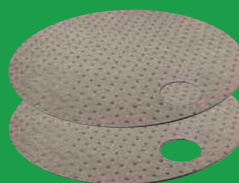

Diameter	Thickness
55 cm	3 mm

SORBING ROLLS (FOR COLLECTING OIL, OILS AND PETROLEUM PRODUCTS)

Composition: 100% polypropylene

Absorbable substances: oil, petroleum products, cutting fluid, solvents

Perforation: no / every 50 cm

Color: White, Gray

Reuse: 50%

Packing: 1 roll



The size	Absorbent container (1 roll)	Weight (1 roll)
40cm*60m*3mm	162l	6 kg
80cm*60m*3mm	324l	12 kg
40cm*30m*4mm	144l	6 kg

ABSORPTIVE SHEETS (FOR COLLECTING OIL, OILS AND PETROLEUM PRODUCTS)

Composition: 100% polypropylene

Absorbable substances: oil, oil products, cutting fluids, solvents

Perforation: yes

Color: White, Gray

Reuse: 50%

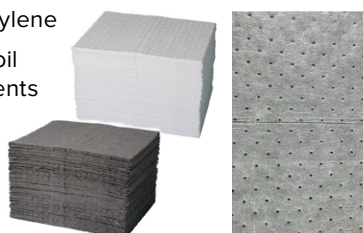

The size	Absorbent container (100 pcs.)	Weight of 1 (one)
400x500x2mm	144l	8 kg
400x500x3mm	216l	14 kg

Packing: 200 pcs.



E-mail: contact@econadin.com
 WhatsApp Business: +380667404649
 Web: www.econadin.com,
www.econad.co.uk

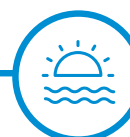



CHEMICAL ABSORBENT MATERIALS

ABSORBING MATERIALS

Absorb organic (vegetable), technical and synthetic oils, oil and oil products, and other aggressive pollutants.

PURPOSE OF ABSORBING MATERIALS:

- elimination of oil pollution on water and solid surfaces;
- cleaning (wiping) equipment surfaces;
- preventing the entry of pollutants into the environment;
- elimination of significant spills of pollutants;
- purification of waste water from oil products;
- protection of storm sewers.

MATS FOR COLLECTING CHEMICALS

Composition: polypropylene fibers + synthetic material

Absorbable substances: acids, alkalis, others chemical aggressive substances

Yellow color

Reuse: 50%

Packing: 16 pcs.



The size	Absorbent container (100 pcs.)	Weight (1 piece)
500x400x40 mm	200 l	0.25kg
200x350x100 mm	200 l	0.4kg

ROLLS SORBING CHEMICALS

Composition: 100% polypropylene fibers

Absorbable substances: acids, alkalis, others chemical aggressive substances

Perforation: every 50 cm

Yellow color

Reuse: 50%

Packing: 1 roll



The size	Absorbent container (1 roll)	Weight (1 roll)
40cm*50m*3mm	90 l	5 kg
80cm*50m*3mm	180 l	10 kg

SHEETS FOR COLLECTING ACIDS AND ALKALI

Composition: 100% polypropylene fibers

Absorbable substances: acids, alkalis, others chemical aggressive substances

Perforation: yes

Yellow color

Reuse: 50%

Packing: 200pcs.



The size	Absorbent container (1 roll)	Weight (1 roll)
400x500x2mm	128 l	8 kg
400x500x3mm	192 l	14 kg



E-mail: contact@econadin.com
 WhatsApp Business: +380667404649
 Web: www.econadin.com,
www.econad.co.uk





MAGNETIC SEALING MAT

The magnetic sealing mat is designed for the quick, temporary closure of hatches, drains, manhole covers, and similar applications.

It is made from 8-millimeter thick polyurethane for durability and reliability.

- + The sealing mat provides rapid temporary sealing of hatches, drains, and similar devices, preventing leaks of hazardous substances.
- + The material is highly resistant to most chemicals, oils, and aqueous liquids.
- + The sealing mat is made from durable polyurethane designed for multiple uses. It can be easily cleaned with soap and water, making it an economical and practical solution.



Note: Sealing mats are not intended for walking on and do not conduct electricity.

In addition to standard diameters of Ø 450 mm and Ø 850 mm, it is possible to order this product with individual characteristics tailored to the customer's needs.

The Sealing Magnetic Mat is recommended for use in the following situations:

- + For temporary sealing in emergency situations.
- + For preventive purposes, preventing potential leaks.
- + As protection against leaks of hazardous substances.

Flexible and airtight, this material provides optimal adhesion to surfaces and is equipped with a magnetic strip underneath for secure attachment to hatches and metallic surfaces.

TECHNICAL SPECIFICATIONS

Material thickness	8 mm
Material	Polyurethane
Version	Universal
Application	Leak response (emergency), leak prevention
Feature	Guiding / restraining / capturing
Leak Type	Spray, surface leakage, non-sealing
Frequency of Use	Multiple
Application Area	Interior and exterior
Product Type	Flexible sealants



E-mail: contact@econadin.com
WhatsApp Business: +380667404649
Web: www.econadin.com,
www.econad.co.uk





WATER ABSORBING BOOMS

Water absorbent booms for flood control are designed to absorb and manage excess water during flood events, rather than oil.



FEATURES:

- + High water absorption: These booms are capable of absorbing large volumes of water quickly, preventing further spread of floodwater.
- + Lightweight and easy to deploy: Designed for rapid deployment, they can be easily moved and positioned as needed during flood emergencies.
- + Durable materials: Made from high-strength fabric, these booms can withstand prolonged exposure to water without tearing or degrading.
- + Reusable and easy to store: Once the water is released, the booms can be reused after drying, making them cost-effective for repeated use.
- + Flexible design: Can be molded around doorways, foundations, or other areas to create a water barrier.

APPLICATIONS:

- + Flood control: Ideal for protecting buildings, warehouses, and infrastructure from flood damage by absorbing and containing water.
- + Stormwater management: Used in construction sites or urban areas to manage excess water during heavy rainfalls and prevent flooding.
- + Water diversion: Helps to redirect water flow away from sensitive areas such as basements, roads, or commercial properties.
- + Residential use: Homeowners can use water-absorbent booms to protect doorways, garages, and low-lying areas from floodwater intrusion.



E-mail: contact@econadin.com
WhatsApp Business: +380667404649
Web: www.econadin.com,
www.econad.co.uk





ECONAD

WATER ABSORBING BOOMS

These booms are an essential tool for flood preparedness, helping to minimize damage and mitigate water spread during heavy rains or natural disasters.

SPECIFICATIONS:

Diameter	Length	Sorption capacity 1pcs	Weight 1pcs	Availability
127 mm	3000 mm	24-36 l	2 kg	in stock
200 mm	3000 mm	48-54 l	3 kg	in stock

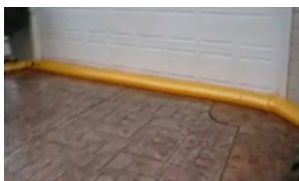

E-mail: contact@econadin.com
 WhatsApp Business: +380667404649
 Web: www.econadin.com,
www.econad.co.uk





MOISTURE ABSORPTIVE MATS

ABSORPTIVE MATS from ECONAD are designed to absorb water and moisture residues during floods. These mats are made from a special fabric filled with synthetic material that can absorb significant amounts of moisture, ensuring high sorption capacity.



WATER ABSORPTIVE MATS from ECONAD are specifically designed to absorb water and residual moisture during flooding. The mats are made of durable fabric filled with synthetic material, allowing them to absorb large quantities of water, providing excellent absorption performance.

ABSORBING MATS are used to control, contain, and divert floodwater. They are ideal for protecting doorways, garages, containing leaks from hot water tanks, controlling erosion, and more, making them a versatile solution for flood management.

ABSORPTIVE MAT SIZES:

Length, mm	Width, mm
500	400
1000	400
500	800



E-mail: contact@econadin.com
WhatsApp Business: +380667404649
Web: www.econadin.com,
www.econad.co.uk





AIR LIFTING BAGS

Totally enclosed
underwater buoyancy

FEATURES AND ADVANTAGES:

- + Totally enclosed cylindrical shape design for enhanced buoyancy and stability
- + Customized sizes and types available to meet specific lifting requirements
- + Compact folding for easy shipment and storage
- + High-flow safety valves that activate under high pressure, ensuring safe operation
- + Complete with accessories, including shackles, valves, and belts for quick setup
- + Made of UV-resistant, PVC-coated fabric for durability in harsh environments
- + Assembly tested with a safety factor of 5:1 to ensure reliability and performance

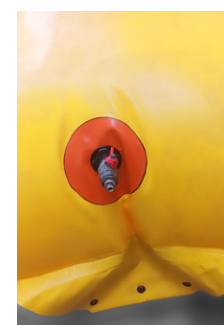

1 Cutting Material



2 HF Welding

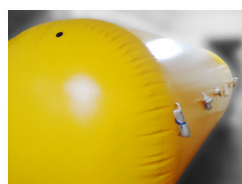

3 Air Tightness Inspection



4 Accessories Assembly



5 Proof Load Testing



6 Package

Used for buoyancy support, marine salvage, refloatation operation in shallow water. It is ideal buoyancy for the pipeline laying from surface to any water depth.

We also can use enclosed lifting bags as support/salvage pontoons for bridges, floating platforms, docks gates, sunken objects and military equipment.



E-mail: contact@econadin.com
WhatsApp Business: +380667404649
Web: www.econadin.com,
www.econad.co.uk





AIR LIFTING BAGS

Totally enclosed
underwater buoyancy

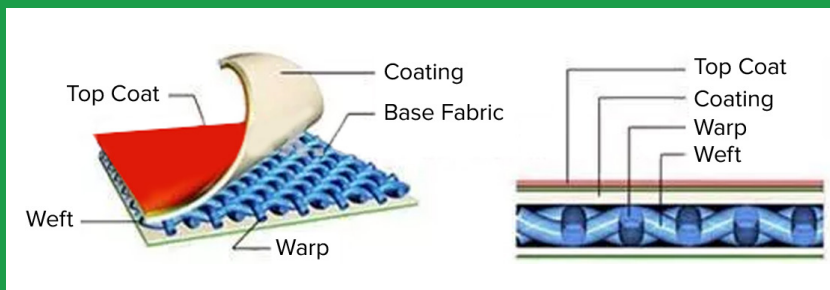

Totally enclosed underwater buoyancy air lifting bags provide an efficient method for reducing the draught of vessels and floating underwater structures. They also offer an ideal buoyancy system for supporting cables, pipelines, and providing static buoyancy support.

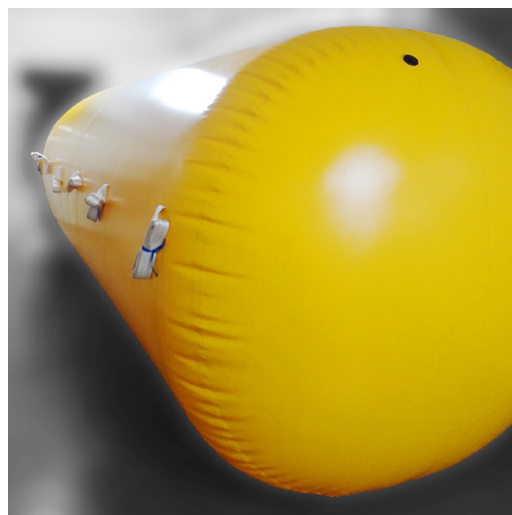
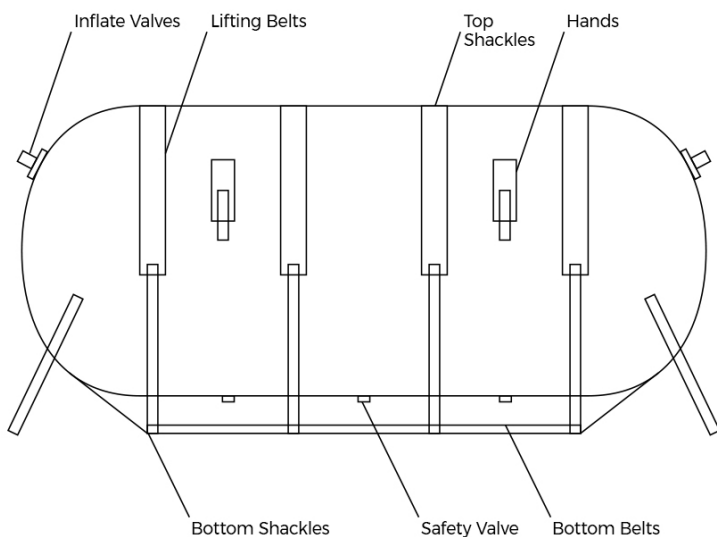

E-mail: contact@econadin.com
WhatsApp Business: +380667404649
Web: www.econadin.com,
www.econad.co.uk

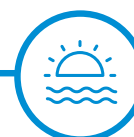



WATERWEIGHT BALLOONS FOR WEIGHT TESTING

Water bags are used to measure the carrying capacity of ladders and cranes during load testing. The water bag for crane load testing consists of a 60 mm wide sling at the top, and is secured at the bottom with staples, while the ring is fastened with a pin. Made from durable PVC fabric, the number of slings varies depending on the model. These bags are typically used in maritime applications.

ECONAD supplies various models of water bags for crane load testing, offering modifications to suit different load capacities and testing requirements.



ADVANTAGES OF WATER BAGS FOR CRANE LOAD TESTING:

- **High-Density Fabric:** Made from 900 g/m² fabric, ensuring long-lasting use without tears or damage.
- **Convenient Assembly:** Our water bags are designed for easy setup. When you purchase water bags for crane load testing from us, you receive high-quality equipment for accurately measuring the load capacity of cranes and gangways. Additionally, we offer a range of other products to help you address oil pollution effectively.

Type	WB 1T	WB 2T	WB 3T
Carrying capacity	2 t	3 t	5 t
Diameter, m	1	1.2	2
Height, m	1	2.5	3.5
Fabric density, g/m ²	900		
Number of slings	4	6	8



E-mail: contact@econadin.com
 WhatsApp Business: +380667404649
 Web: www.econadin.com,
www.econad.co.uk





OIL SUMP TRAY

The Oil-Collecting Tray with a Grid serves as a stand for barrels and containers, designed to localize spills of petroleum products and technical fluids. The integrated grid prevents spills from spreading onto the floor, while the tray is equipped with protective doors and hatches on the sides and top for easy access.

The tray is ideal for the temporary storage of oil products in containers and barrels, preventing leaks and spills onto hard surfaces in industrial settings, warehouses, and other facilities.

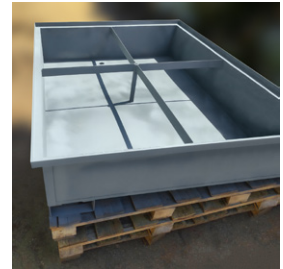

KEY FEATURES:

- + **Durable Construction:** Made from high-quality metal coated with polymer paint and varnish for protection against oil products, UV light, and chemicals.
- + **Removable Grid:** Allows for easy cleanup and access in the event of spills.
- + **Spill Containment:** Prevents oil and technical fluids from contaminating work areas, enhancing safety and cleanliness.
- + **Protective Doors and Hatches (only for the type OST 2B):** Equipped with side and top access points for convenient operation.

This oil-collecting tray is a practical solution for ensuring the safe and effective containment of oil products, protecting workspaces from spills and environmental hazards. The permissible temperature range for the storage and operation of the pallet is from -30°C to +60°C.



E-mail: contact@econadin.com
WhatsApp Business: +380667404649
Web: www.econadin.com,
www.econad.co.uk





OIL SUMP TRAY



Removable grill



Oil sump tray OST 2

Characteristics	Oil sump tray OST 2
Tray/Grate Material	Metal
Grille	Removable
Color	Blue
Coating	Polymer chemical resistant paint
Quantity, items.	1
Volume, m ³	1.15
Overall dimensions in working condition, mm	1550x1550x720
Operating volume of the tank, l	1000
Metal legs, pcs.	4
Additional equipment	Drain nozzle (mouth) with plug (plug)
Weight, kg	150
Warranty period of operation	1 year



E-mail: contact@econadin.com
 WhatsApp Business: +380667404649
 Web: www.econadin.com,
www.econad.co.uk





OIL SUMP TRAY



Oil sump tray OST 2B

Characteristics	Oil sump tray OST 2B
Tray/Grate Material	Metal
Grille	Removable
Color	Blue
Coating	Polymer chemical resistant paint
Quantity, items.	1
Volume, m ³	1.15
Overall dimensions of the pallet (w*d*h), mm	1490*990*1690
Overall dimensions in working condition (w*d*h), mm	1450x1450x2165 (dimensions taking into account the installed protective cover)
Operating volume of the tank, l	1000
Metal legs, pcs.	4
Additional equipment	Drain pipe with plug, door and two hatches.
Weight, kg	375
Warranty period of operation	1 year



E-mail: contact@econadin.com
 WhatsApp Business: +380667404649
 Web: www.econadin.com,
www.econad.co.uk





OIL SUMP TRAY

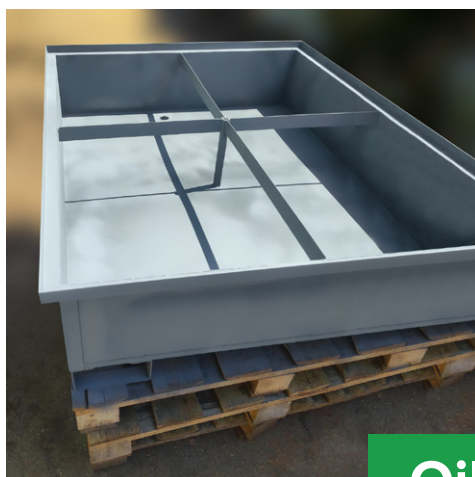

Oil sump tray OST 1



Characteristics	Oil sump tray OST 1
Tray/Grate Material	Metal
Grille	Removable
Color	Gray
Coating	Paint with protective coating "cold zinc"
Quantity, pcs.	1
Volume, m ³	0.532
Overall dimensions (length/width/height), mm	1276x1064x392
Internal dimensions (length/width/height), mm	1000x1212x392
Operating volume of the tank, l	144
Metal legs, pcs.	4
Additional equipment	Drain nozzle (mouth) with plug (plug)
Weight, kg	54.20
Warranty period of operation	1 year





OIL BERMS "ECONAD"

Collapsible Bunds & Spill Mats

"ECONAD" berms are a reliable solution for the localization of emergency spills of oil and petroleum products. They are designed to hold liquids in place and prevent them from spreading, thus ensuring safety and control during work in industrial environments.



KEY APPLICATIONS OF BERMS INCLUDE:

- As stationary or temporary reservoirs for containment of hydrocarbon spills;
- For temporary storage of liquids during maintenance or repair;
- As a container for equipment decontamination;
- To protect against accidental leaks during pipeline repairs.

"ECONAD" berms/pallets are easy to use, durable and provide reliable solutions for prompt response to accidents.

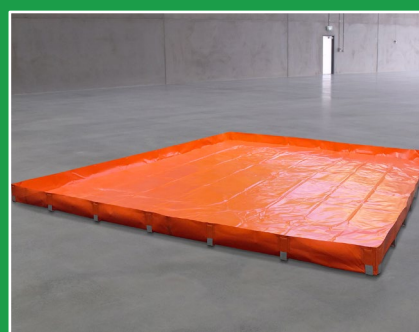

E-mail: contact@econadin.com
WhatsApp Business: +380667404649
Web: www.econadin.com,
www.econad.co.uk





OIL BERMS "ECONAD"

Collapsible Bunds & Spill Mats

"ECONAD" PVC berms/pallets are important for large companies and factories that work with petroleum products. These berms are intended for secondary containment of spills, as well as decontamination or wash-down stations. They are designed to provide maximum efficiency in conditions where safety and speed of response are important.



Model	Volume, l	Length, m	Width, m	Depth, m	Weight with packaging, kg
EKT-1	0.3	1.00	1.00	0.3	8.00
EKT-3	0.9	2.00	1.5	0.3	13.6
EKT-5	1.5	2.50	2.00	0.3	15.00
EKT-8	2.42	4.00	2.00	0.3	17.6
EKT-10	3.00	5.00	2.00	0.3	20.00
EKT-12	3.6	4.00	3.00	0.3	22.4
EKT-14	4.2	3.5	4.00	0.3	24.8
EKT-16	4.8	4.00	4.00	0.3	28.8
EKT-19	5.77	5.5	3.5	0.3	35.6
EKT-20	6,12	4.0	5.10	0.3	39.40
EKT-49	14.82	8.1	6.1	0.3	85.60





TANKS FOR PETROLEUM PRODUCTS

The tank is a prefabricated frame made of steel parts, inside which a hermetic canopy made of strong polymer fabric is installed. Installation is carried out in a short time without the use of tools. In addition, the structure can be strengthened with walls made of moisture-resistant plywood 6 mm thick, which is placed in a protective shell made of polyethylene foam. The shell is made of synthetic material with a PVC coating.



The main purpose of the structure is the temporary storage of oil products collected from the surface of the water after localization and collection of oil products during emergency oil spills.

ECONAD supplies various modifications of oil collection tanks.



E-mail: contact@econadin.com
WhatsApp Business: +380667404649
Web: www.econadin.com,
www.econad.co.uk





TANKS FOR PETROLEUM PRODUCTS

Characteristic	Tank volume 3 m ³	Tank volume 30 m ³	Ladder
Structural stability	Construction made of moisture-resistant plywood 6 mm thick, which is placed in a protective case sheath made of polyethylene foam.		
Frame	Made of steel sections		
Outer shell	It is made of material with a synthetic base, with a double-sided PVC coating. The material is resistant to the influence of oil and oil products, sea water and ultraviolet light. The underlying surface can be provided, which is covered with a protective polyethylene flooring and a covering canopy is provided.		
Construction seams	Made by high-frequency current welding (TVC method)		
Color	Yellow, orange.		
Ambient temperature	Storage and operation of the container from -30°C to +60°C.		
Oversized dimensions capacity in the working room state, m	2.25x2.25x1.0	C D=6.6 H=1	
Oversized dimensions in transport condition, m³	0.3	2.2x0.8x1.1	
Weight of container in transport condition, kg	41	550	
Fabric density	Not less than 900 g/m ²		
Childbirth	Polymer fabric material		
Pontoon		extruded polyethylene foam	
Additional equipment, ladder			1 pc.





CLEANING PRODUCTS "UNIVERSAL"

UNIVERSAL CLEANING AGENTS GROUP

Universal cleaning products are universal concentrated products for removing stains of oil products and fats.



CLEANERS ARE INTENDED FOR:

- for cleaning rolling stock on the railway, nodes, assemblies, etc .;
- for washing containers, tanks and other types of storages for oil products and other hydrocarbons, as well as oils of vegetable origin;
- for cleaning floors, equipment, containers, containers of devices and mechanisms that do not have direct contact with food;
- for washing filter equipment from hydrocarbons;
- for washing off oil pollution from asphalt concrete pavements;
- for washing trunk or local liquid hydrocarbon transportation systems;
- for washing watercraft, booms, oil recovery equipment, including components, assemblies, tanks, tanks, etc .;
- for cleaning surfaces, walls, ceramic tiles in the home, trade and consumer services.



E-mail: contact@econadin.com
WhatsApp Business: +380667404649
Web: www.econadin.com,
www.econad.co.uk





BUOYS AND FENDERS

Buoy – float, signaling the place of anchoring when installing booms.

ECONAD supplies various modifications of buoys.

BUOY BENEFITS:

Made of durable material (polyethylene) that does not bleed on impact and can withstand large temperature changes.

Simplicity and lightness of construction.

Buying buoys from us you get high-quality equipment, on our website you can purchase related equipment that will help get rid of oil pollution.



Specifications	
Diameter, mm	250
Volume, l	12
Weight, kg	0.5
Height, mm	390



E-mail: contact@econadin.com
 WhatsApp Business: +380667404649
 Web: www.econadin.com,
www.econad.co.uk





ANCHORS

Anchor – a forged or cast construction designed for holding the buoy in the same place due to the interaction with the ground and associated with the object hold by the anchor chain or cable.

Weight -10 -15 kg.

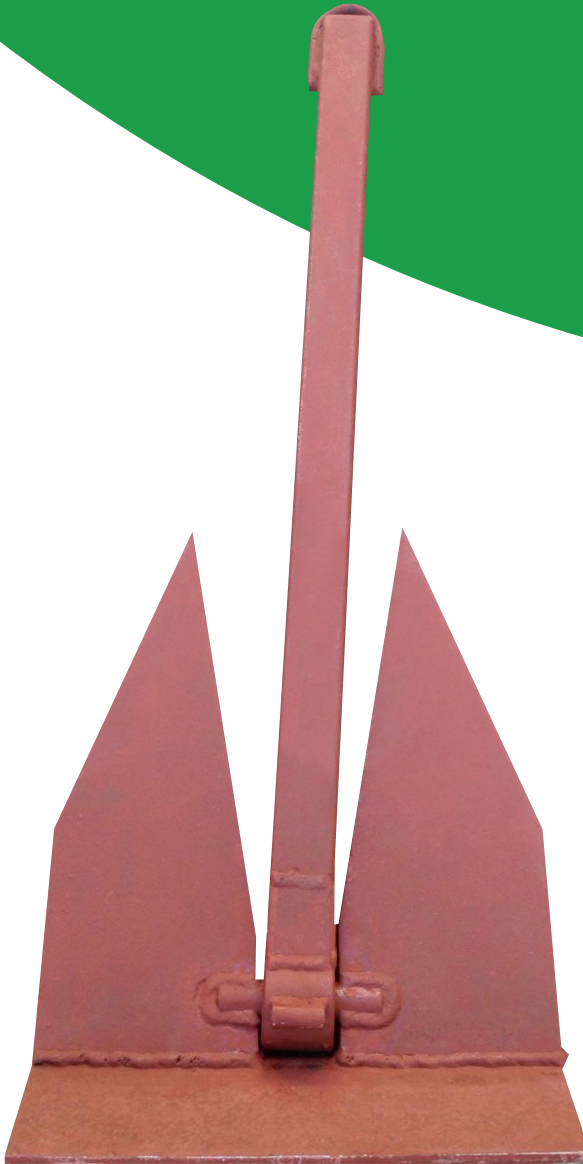

DENFORT ANCHOR:

- Has a maximum convergence of long swivel feet, stretched out along the spindle and is able to go into the ground to a depth of 3-4 times the length of its paws
- Rodless anchor of increased holding power ;
- Made from steel and protected from corrosion by hot dip galvanizing;
- Recommended for use on soft ground (mud, sand, gravel).

LinkedIn



E-mail: contact@econadin.com
WhatsApp Business: +380667404649

ECONAD, Ukraine 65005, Odesa,
st. Melnitskaya 26/2. Tel: +38(048)737-37-51



Web: www.econadin.com
www.econad.co.uk



ECONAD



ANCHORS BENEFITS:

- It has a simple structure, which ensures its reliable operation in harsh environments.
- endowed with an elevated drainage force.
- elongated rod is located at the bottom and serves as a stabilizer, which does not allow the anchor to tip over on its side.



Характеристики

The length of the spindle, mm.	713
Swipe horns, mm.	306
Weight, Kg	10-12
Drainage force	to 50 Kg for each kg of anchor
Material	Steel, mark 3 (model AN3) Galvanizing Steel (model AN2)

Additional models of anchors with varying weights and purposes are available on our website.



LinkedIn



E-mail: contact@econadin.com | WhatsApp Business: +380667404649

Web: www.econadin.com, www.econad.co.uk

ECONAD, Ukraine 65005, Odesa, st. Melnitskaya 26/2. Tel: +38(048)737-37-51